



# Q-Lon Polyurethane Foam Seals: for timber, PVC and aluminium applications

*THE WORLD'S BEST SEALS*



The Schlegel  
*Promise!*

## CONTENTS

About Schlegel	3
Q-Lon Polyurethane Foam Seals	4
Universal Surface Fitted Applications	6
Timber Window and Entry Door Applications	8
PVC Window and Door and Window Covering Product Applications	16
Aluminium Window and Door and Window Covering Product Applications	24
Interior design: Internal Door and Furniture Applications	28
Accessories and Tools	36
Colour Range	38
Case Study	39

# Schlegel: providing experience in the best sealing technology

**With almost 50 years of global experience in the design and manufacture of outstanding window and door products, it is little wonder that Schlegel has become the industry's first choice for foam, brush and extruded seals.**

The unique Q-Lon seal has been developed in consultation with our customers to offer the widest range of polyurethane (PU) foam seals possible for timber, PVC and aluminium windows and doors, window covering products and interior design. The unique design has made Q-Lon the seal of choice for many applications. Authentic Q-Lon seals are impervious to paint and stain, while still providing some of the best energy saving performance characteristics currently available.

Our products are manufactured to meet the requirements of many current and proposed British, German, Spanish and related European and international standards and are manufactured using a Quality Management System registered and certified to norm ISO 9001:2008. Backed by our 10 year guarantee, original Q-Lon seals are a safe choice. Compared with common sealing systems, the Q-Lon range provides a cost effective way of offering continuous high standards of sealing, year after year.

**Tested and certified by:**

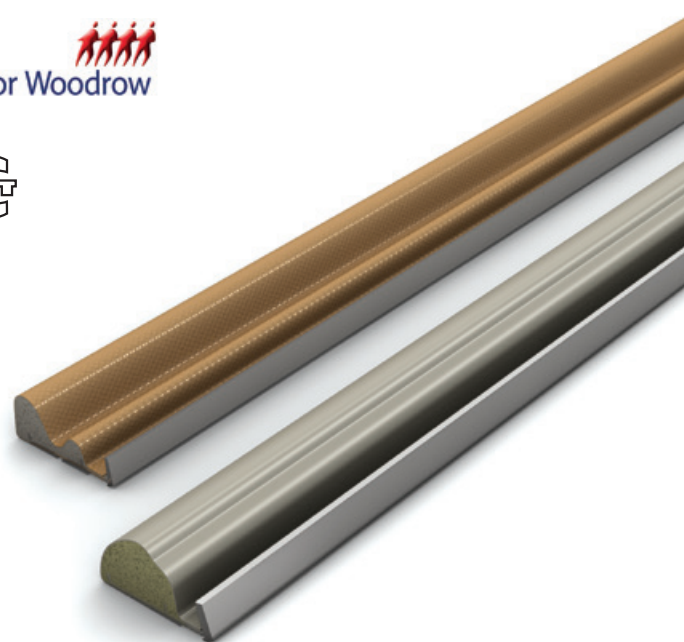

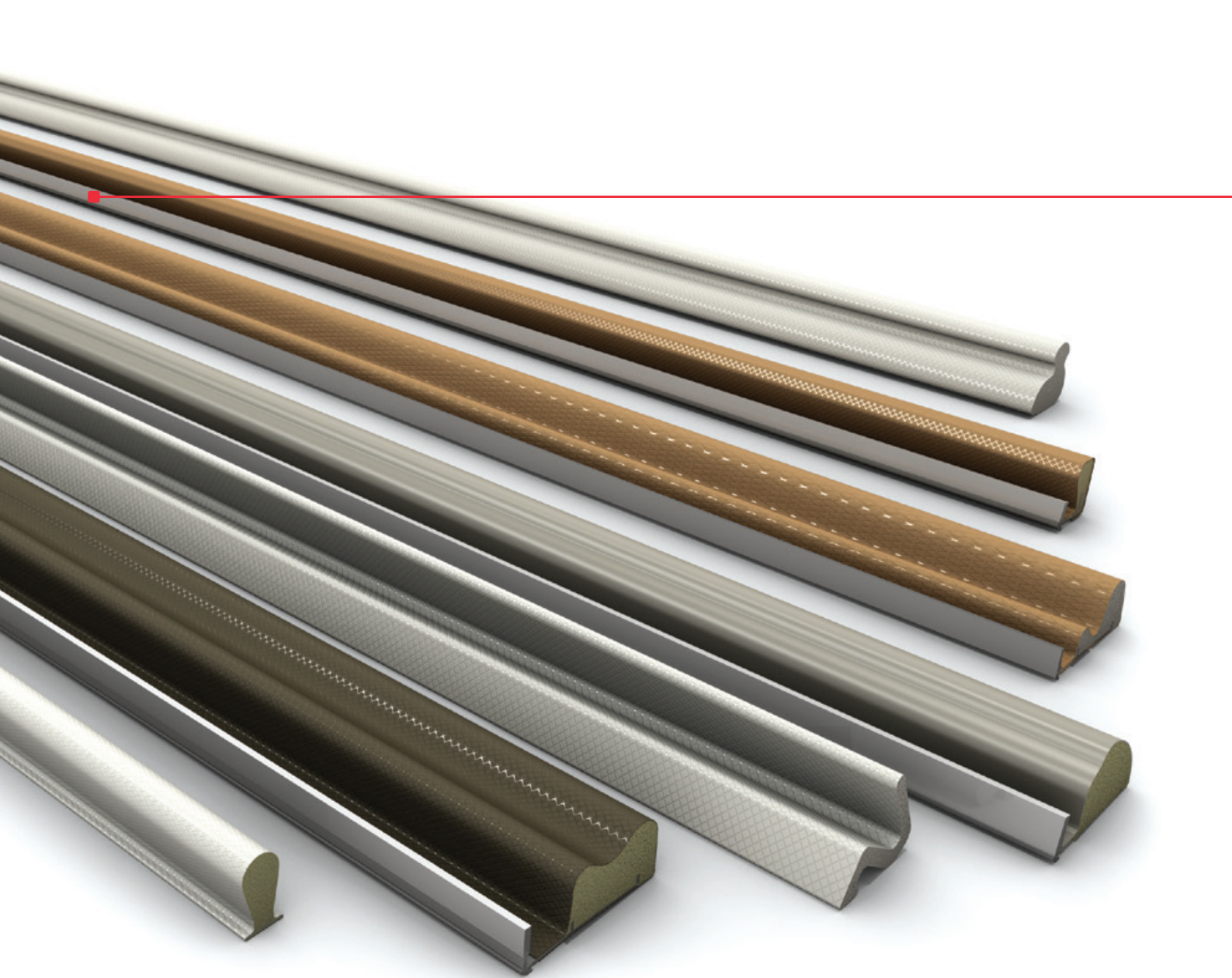

Image courtesy of Origin

- Polyurethane (PU) foam core – high durability, superior recovery performance
- Polyethylene (PE) film – weather and UV-resistant
- Glass fibre thread or polypropylene (PP) insert – prevents elongation and shrinkage
- Smooth or embossed exterior, resistant to contamination
- Compatible with cleaning agents

# Q-Lon Polyurethane Foam Seals: proved and tested for almost 50 years

**Made with a unique combination of materials and with technical performance unparalleled by any other material used in seals, Schlegel Q-Lon offers the highest standard of sealing function – even under extreme conditions.**

Continuous research and development, as well as strict material inspection and quality inspections, have made Q-Lon one of the best established sealing systems in the industry today.

Q-Lon foam seals – the ultimate benefits in material and function:

- **Excellent memory** – returns to original shape after compression
- **Stability** – low / no stretch gained by rigid insert or glass fibre internal cord
- **Easily compressed** – low compression forces, unaffected by temperature variance
- **Acoustics** – outstanding acoustic performance
- **Thermal conductivity** – unrivalled thermal performance
- **Paint and stain proof** – properties unaffected by standard paints and stains
- **Stabilised** – unaffected by rot, fungi, UV-light or ozone
- **Colours** – white, black, brown, grey and many other options
- **Temperatures** – wide operating range under extremely cold and warm weather conditions

## Independent Testing

Q-Lon has been extensively tested by independently certified test facilities that clearly demonstrate its superior performance over other commonly used seal materials and constructions. In particular, it has been shown that Q-Lon seals retain their properties and performance significantly better over time when, after 10,000 cycles of window and / or door opening and closing, other materials lose their ability to meet the normal operational requirements.

Areas affected include weathering performance, thermal insulation, sound attenuation and air tightness.

A good guide to the performance of weatherseals and gaskets can be found in EN 12365:2003. For a greater insight into this and other performance norms please refer to the Schlegel 'Guide to Weatherseal Selection & Specification in Europe'.



# Q-Lon Polyurethane Foam Seals:

for universal surface  
fitting

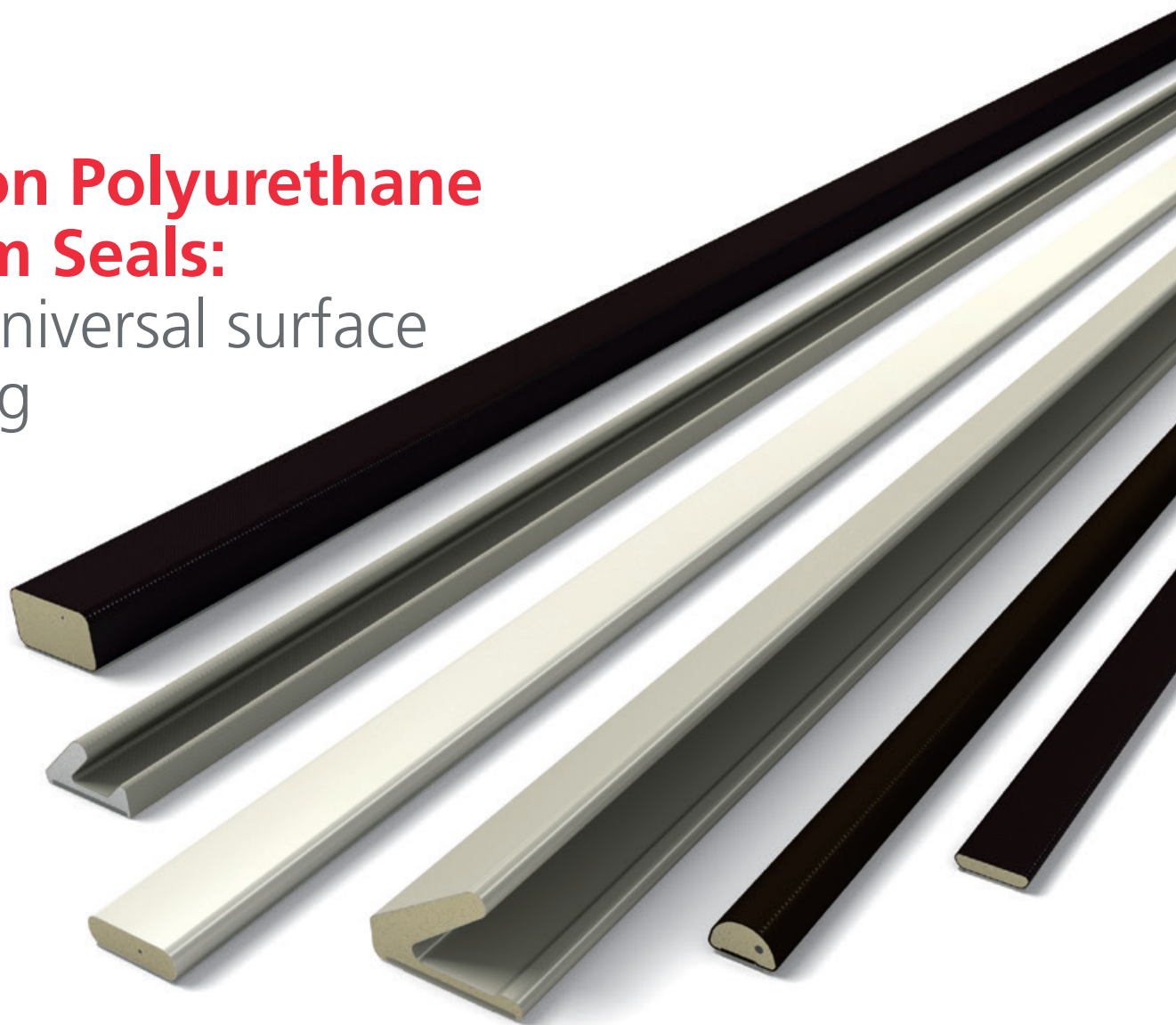

- Universal – direct application on a flat surface
- Fixing with pre-applied adhesive tape
- Alternatively it can be fixed with adhesive tape, hot melt glue or staples
- Available colours: white, black, bronze and grey. Other colours available on request

## QL 3042

Untaped

Width: 11,2

Height: 6,5

Rebate: 11,0

Seal gap: 3,0 - 5,5

Packaging:

400 m x 2

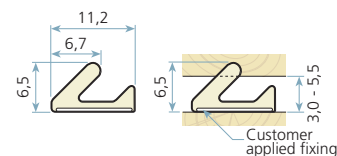

## QL 3059

Untaped

Width: 10,8

Height: 8,7

Rebate: 11,0

Seal gap: 3,0 - 5,5

Packaging:

300 m x 2

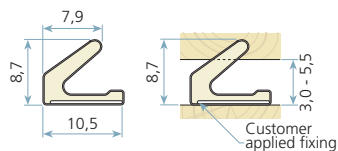

## QL 3061

Untaped

Width: 15,0

Height: 12,0

Rebate: 15,0

Seal gap: 5,0 - 10,0

Packaging:

250 m x 2

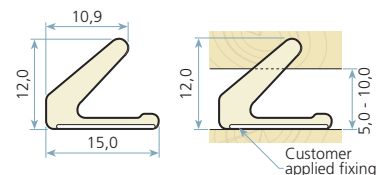

### QL 1026

**Taped**

Width: 12,0  
 Height: 4,0  
 Rebate: 12,0  
 Seal gap: 1,0 - 3,0  
 Packaging:  
 250 m x 2 / 500 m x 2

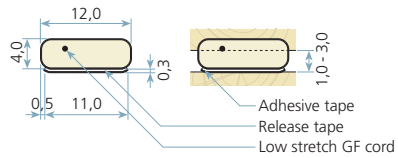

### QL 1032

**Taped**

Width: 12,0  
 Height: 7,0  
 Rebate: 12,0  
 Seal gap: 2,0 - 6,0  
 Packaging:  
 250 m x 2 / 500 m x 2

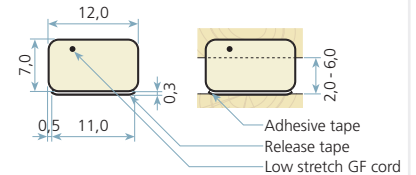

### QL 3015

**Taped**

Width: 8,0  
 Height: 5,0  
 Rebate: 8,0  
 Seal gap: 2,5 - 4,0  
 Packaging:  
 100 m x 2 / 500 m x 2

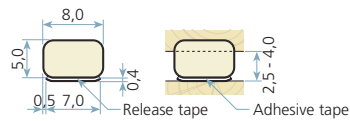

### QL 3115

**Taped**

Width: 6,8  
 Height: 1,5  
 Rebate: 7,0  
 Seal gap: 0,5 - 1,0  
 Packaging:  
 500 m x 1

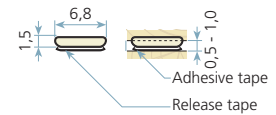

### QL 3116

**Taped**

Width: 10,8  
 Height: 8,7  
 Rebate: 11,0  
 Seal gap: 3,0 - 5,5  
 Packaging:  
 300 m x 2

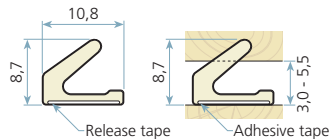

### QL 3117

**Taped**

Width: 11,2  
 Height: 6,5  
 Rebate: 11,0  
 Seal gap: 3,0 - 5,5  
 Packaging:  
 400 m x 2

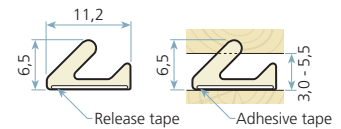

### QL 3121

**Taped**

Width: 15,0  
 Height: 12,0  
 Rebate: 15,0  
 Seal gap: 5,0 - 10,0  
 Packaging:  
 225 m x 2

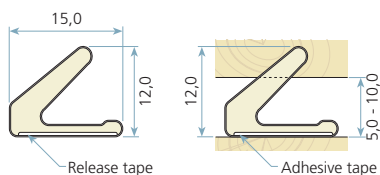

### QL 3122

**Taped**

Width: 7,0  
 Height: 2,2  
 Rebate: 7,0  
 Seal gap: 0,5 - 2,0  
 Packaging:  
 200 m x 2

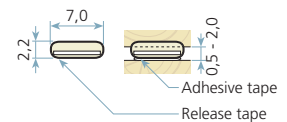

### QL 3124

**Taped**

Width: 6,4  
 Height: 3,7  
 Rebate: 6,0  
 Seal gap: 2,5 - 3,5  
 Packaging:  
 100 m x 2 / 100 m x 7  
 1000 m x 2

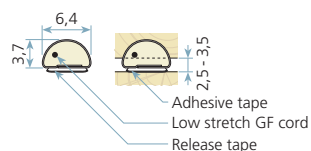

### QL 3126

**Taped**

Width: 10,0  
 Height: 3,0  
 Rebate: 10,0  
 Seal gap: 1,0 - 2,5  
 Packaging:  
 400 m x 1 / 700 m x 2

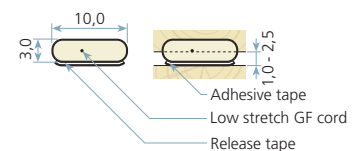



- Efficient processing – right from the coil, no waste
- Suitable for automatic insertion or fixing
- Compatible with all paints and glazes, including acrylic paints
- Available colours: white, black, bronze and grey. Other colours available on request



# Q-Lon Polyurethane Foam Seals:

## for timber window and entry door applications

Specifically designed for timber windows and entry doors, Q-Lon foam seals combine the best thermal performance along with good soundproofing properties across a wide temperature range. Very low operating forces reduce wear and tear and give ease of operation.

### Testing and results

Compression set:	< 15% after 1 hour relief of 50% compression at 70 °C and 24 hours (DIN 53572)
Compression force:	approx. 15 N at 25% compression per 100 mm, < 10 N for lip profiles
Tested temperature range:	-60 °C to +70 °C
Heat conductivity:	0.06 W/mK at 0 °C
Long life performance:	no change of the length-related and partial joint permeability
Environment testing:	tested and passed pursuant to DIN 18055, EN 12207 and EN 12208 to 600 Pa at single and French window
Paint compatibility:	no adhesion, no hardening, no discolouration
Acoustic testing:	43 dB at a window IV68 with a centre seal 45 dB at a window IV76 with centre and overlap seals
Weather-resistant:	tested up to 20 years



# For timber window and entry doors

## QL 650

### Entry doors

Groove width:  
2,7 - 3,0  
Min. groove  
depth: 6,0  
Rebate: 13,5  
Seal gap: 8,0 - 15,0  
Packaging:  
2,1 m x 150

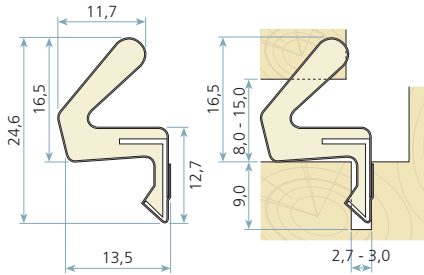

## QL 3004

F

### Windows

Groove width:  
2,7 - 3,0  
Min. groove  
depth: 6,0  
Rebate: 10,5  
Seal gap: 3,0 - 5,0  
Packaging:  
350 m x 2

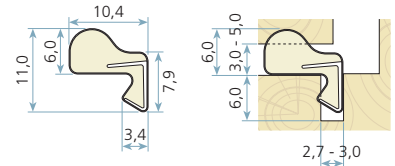

## QL 3005

F

### Windows

Groove width:  
2,7 - 3,0  
Min. groove  
depth: 6,0  
Rebate: 8,0  
Seal gap: 3,4 - 5,4  
Packaging:  
300 m x 2

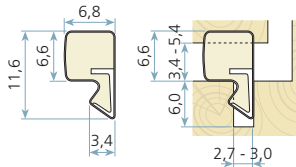

## QL 3006

F

### Windows

Groove width:  
2,7 - 3,0  
Min. groove  
depth: 6,0  
Rebate: 13,0  
Seal gap: 5,0 - 13,0  
Packaging:  
2,1 m x 150

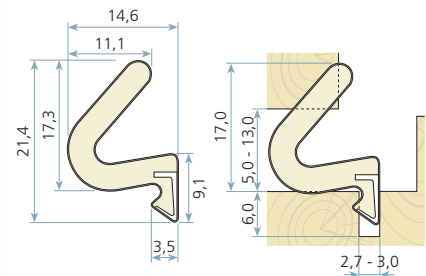

## QL 3009

F

### Entry doors / Windows

Groove width:  
2,7 - 3,0  
Min. groove  
depth: 6,0  
Rebate: 11,0  
Seal gap: 4,0 - 7,5  
Packaging:  
250 m x 2

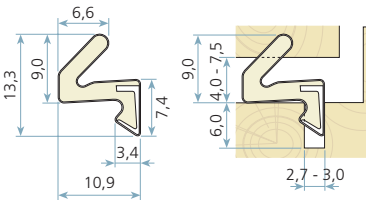

## QL 3011

F

### Windows

Groove width:  
2,7 - 3,0  
Min. groove  
depth: 6,0  
Rebate: 10,0  
Seal gap: 3,5 - 5,5  
Packaging:  
250 m x 2

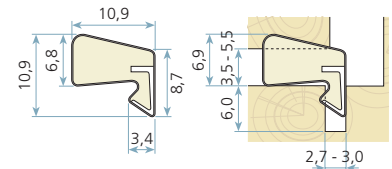

## QL 3012

F

### Windows

Groove width:  
2,7 - 3,0  
Min. groove  
depth: 6,0  
Rebate: 11,0  
Seal gap: 4,0 - 6,5  
Packaging:  
200 m x 2

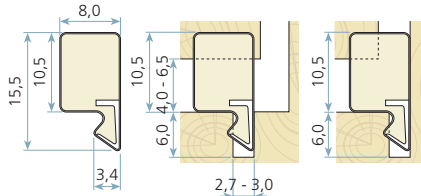

## QL 3013

F

### Windows

Groove width:  
2,7 - 3,0  
Min. groove  
depth: 6,0  
Rebate: 8,0  
Seal gap: 2,0 - 3,0  
Packaging:  
500 m x 2

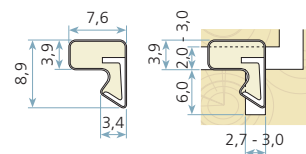

## QL 3025

F

### Windows

Groove width:  
2,7 - 3,0  
Min. groove  
depth: 6,0  
Rebate: 10,5  
Seal gap: 3,0 - 5,0  
Packaging:  
350 m x 2

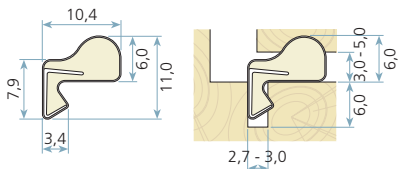

## QL 3034

O

### Windows

Groove width:  
2,7 - 3,0  
Min. groove  
depth: 8,0  
Rebate: 8,5  
Seal gap: 0,0 - 1,5  
Packaging:  
400 m x 2

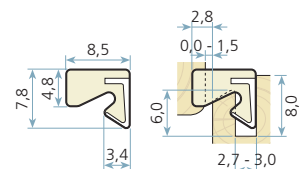

# For timber window and entry doors

## QL 3037 F

### Windows

Groove width:  
2,7 - 3,0  
Min. groove  
depth: 6,0  
Rebate: 10,0  
Seal gap: 3,5 - 5,6  
Packaging:  
200 m x 2

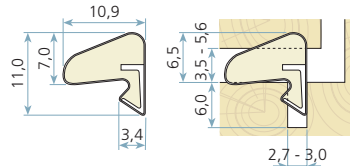

## QL 3053 C

### Windows

Groove width:  
4,0 - 5,0  
Min. groove  
depth: 7,5  
Rebate: 12,0  
Seal gap: 4,5 - 6,0  
Packaging:  
200 m x 2

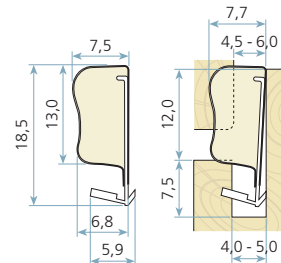

## QL 3054 O

### Windows

Groove width:  
2,8 - 3,2  
Min. groove  
depth: 5,5  
Rebate: 10,0  
Seal gap: 4,0 - 6,0  
Packaging:  
250 m x 2

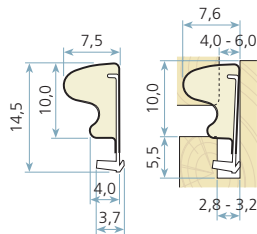

## QL 3063 C

### Windows

Groove width:  
4,0 - 5,0  
Min. groove  
depth: 7,5  
Rebate: 12,0  
Seal gap: 5,5 - 7,5  
Packaging:  
200 m x 2

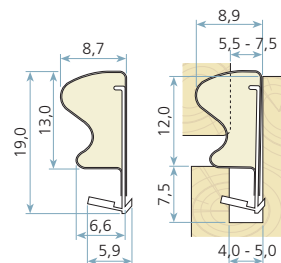

## QL 3064 C

### Windows

Groove width:  
4,0 - 5,0  
Min. groove  
depth: 7,5  
Rebate: 12,0  
Seal gap: 4,5 - 6,0  
Packaging:  
200 m x 2

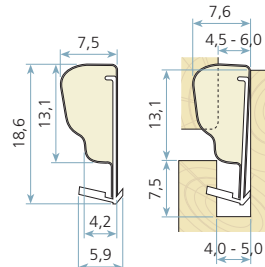

## QL 3067 C

### Windows

Groove width:  
4,0 - 5,0  
Min. groove  
depth: 7,5  
Rebate: 12,0  
Seal gap: 4,0 - 6,0  
Packaging:  
200 m x 2

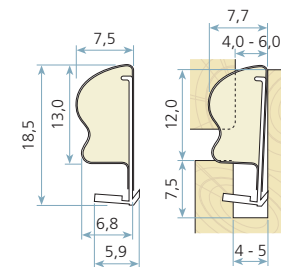

## QL 3068 C

### Windows

Groove width:  
3,4 - 4,2  
Min. groove  
depth: 6,5  
Rebate: 11,0  
Seal gap: 4,5 - 6,5  
Packaging:  
200 m x 2

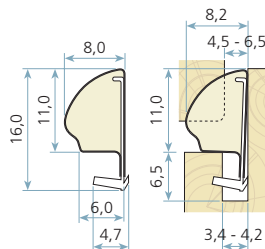

## QL 3070 O

### Windows

Groove width:  
2,7 - 3,0  
Min. groove  
depth: 8,0  
Rebate: 8,0  
Seal gap: 0,0 - 1,5  
Packaging:  
400 m x 2

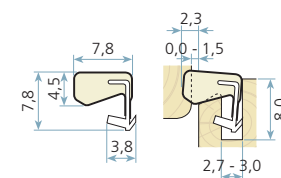

## QL 3072 C

### Windows

Groove width:  
2,7 - 3,2  
Min. groove  
depth: 6,5  
Rebate: 10,0  
Seal gap: 2,7 - 4,3  
Packaging:  
300 m x 2

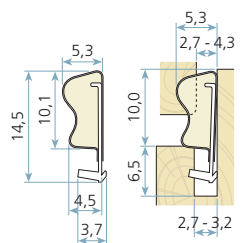

## QL 3073 C

### Entry doors

Groove width:  
4,0 - 5,0  
Min. groove  
depth: 7,5  
Rebate: 13,0  
Seal gap: 5,0 - 8,0  
Packaging:  
150 m x 2 / 200 m x 2

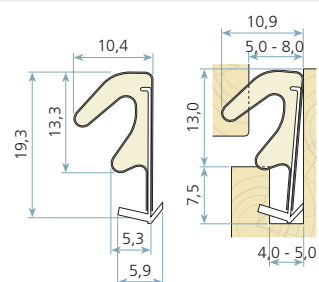

# For timber window and entry doors

## QL 3074

F

### Windows

Groove width:  
2,7 - 3,2  
Min. groove  
depth: 6,5  
Rebate: 8,5  
Seal gap: 3,5 - 5,5  
Packaging:  
300 m x 2

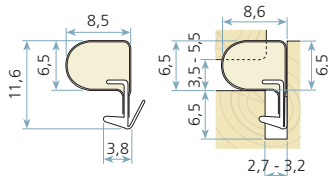

## QL 3076

C

### Windows

Groove width:  
3,0 - 3,5  
Min. groove  
depth: 6,0  
Rebate: 10,0  
Seal gap: 3,0 - 6,0  
Packaging:  
250 m x 2

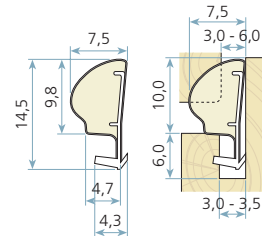

## QL 3077

F

### Windows

Groove width:  
2,7 - 3,0  
Min. groove  
depth: 6,0  
Rebate: 8,0  
Seal gap: 2,0 - 3,0  
Packaging:  
500 m x 2

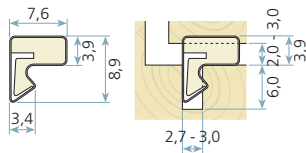

## QL 3078

F

### Entry doors / Windows

Groove width:  
3,0 - 3,3  
Min. groove  
depth: 6,0  
Rebate: 10,5  
Seal gap: 4,0 - 7,5  
Packaging:  
250 m x 2 / 300 m x 2

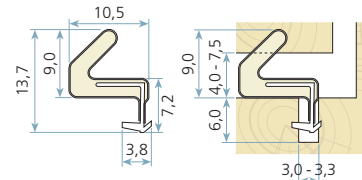

## QL 3079

C

### Entry doors / Windows

Groove width:  
3,2 - 4,0  
Min. groove  
depth: 6,5  
Rebate: 10,0  
Seal gap: 2,7 - 4,3  
Packaging:  
300 m x 2

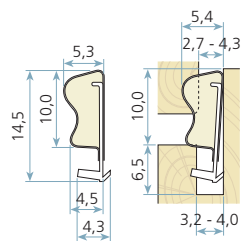

## QL 3091

### Entry doors

Groove width:  
4,0 - 5,0  
Min. groove  
depth: 7,5  
Rebate: 15,0  
Seal gap: 4,0 - 8,0  
Packaging:  
150 m x 2 / 400 m x 1

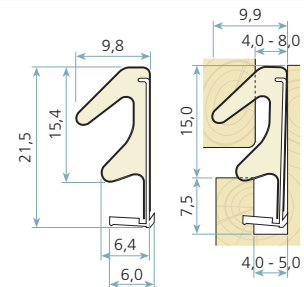

## QL 3093

### Entry doors

Groove width:  
2,7 - 3,0  
Min. groove  
depth: 7,0  
Rebate: 13,0  
Seal gap: 4,0 - 8,0  
Packaging:  
150 m x 2 / 400 m x 1

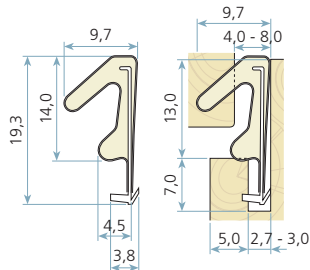

## QL 3094

### Entry doors

Groove width:  
2,7 - 3,2  
Min. groove  
depth: 6,5  
Rebate: 10,0  
Seal gap: 3,0 - 6,0  
Packaging:  
250 m x 2

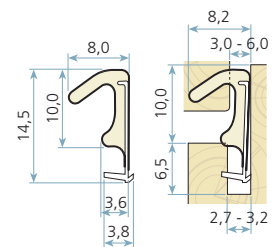

## QL 3095

### Entry doors

Groove width:  
3,5 - 4,0  
Min. groove  
depth: 6,5  
Rebate: 10,0  
Seal gap: 3,0 - 6,0  
Packaging:  
250 m x 2

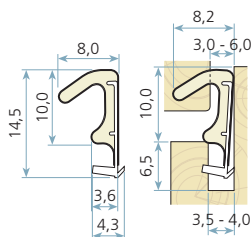

## QL 3096

### Entry doors

Groove width:  
4,0 - 5,0  
Min. groove  
depth: 7,5  
Rebate: 12,0  
Seal gap: 3,0 - 6,0  
Packaging:  
200 m x 2

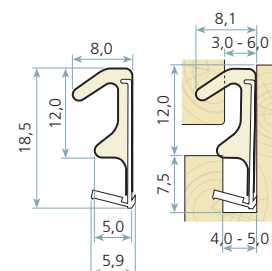

# For timber window and entry doors

## QL 3097

**O**

### Entry doors / Windows

Groove width: 4,0 - 5,0  
 Min. groove depth: 7,5  
 Rebate: 18,0  
 Seal gap: 3,5 - 6,0  
 Packaging: 150 m x 2

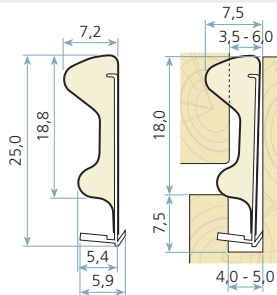

## QL 3098

### Entry doors

Groove width: 3,0 - 4,0  
 Min. groove depth: 7,5  
 Rebate: 14,0  
 Seal gap: 3,0 - 6,0  
 Packaging: 150 m x 2

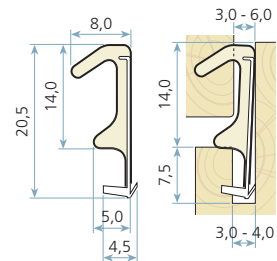

## QL 3099

**F**

### Entry doors / Windows

Groove width: 3,0 - 3,3  
 Min. groove depth: 6,0  
 Rebate: 10,5  
 Seal gap: 4,0 - 7,5  
 Packaging: 250 m x 2 / 300 m x 2

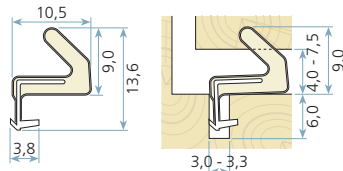

## QL 3101

**C**

### Windows

Groove width: 2,7 - 3,2  
 Min. groove depth: 7,0  
 Rebate: 13,0  
 Seal gap: 3,5 - 6,0  
 Packaging: 200 m x 2

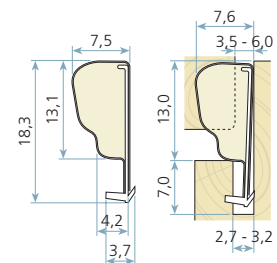

## QL 3102

### Entry doors

Groove width: 3,7 - 4,2  
 Min. groove depth: 7,0  
 Rebate: 11,0  
 Seal gap: 5,0 - 7,5  
 Packaging: 200 m x 2

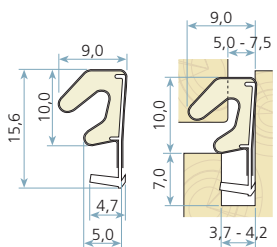

## QL 3103

**C**

### Windows

Groove width: 4,0 - 5,0  
 Min. groove depth: 7,5  
 Rebate: 12,0  
 Seal gap: 5,0 - 7,0  
 Packaging: 200 m x 2

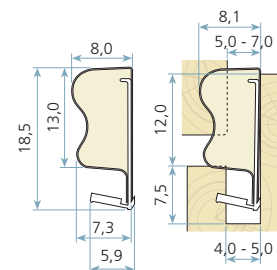

## QL 3104

### Entry doors

Groove width: 4,0 - 5,0  
 Min. groove depth: 7,5  
 Rebate: 12,0  
 Seal gap: 5,0 - 9,0  
 Packaging: 200 m x 2

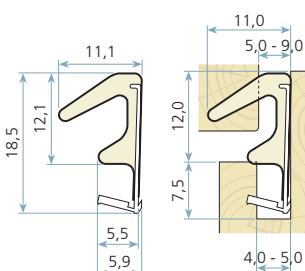

## QL 3109

### Entry doors

Groove width: 4,0 - 5,0  
 Min. groove depth: 7,0  
 Rebate: 18,0  
 Seal gap: 5,0 - 9,0  
 Packaging: 100 m x 2

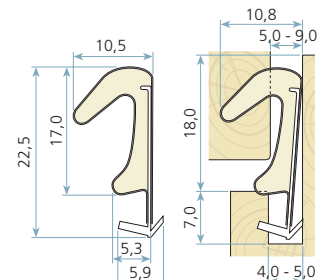

## QL 3111

**C**

### Windows

Groove width: 3,5 - 4,0  
 Min. groove depth: 7,0  
 Rebate: 12,0  
 Seal gap: 3,5 - 4,0  
 Packaging: 200 m x 2

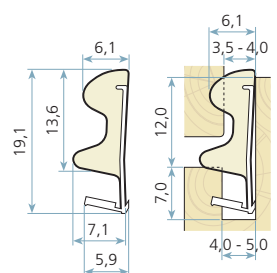

## QL 3118

**F**

### Entry doors / Windows

Groove width: 3,0 - 3,3  
 Min. groove depth: 7,0  
 Rebate: 9,0  
 Seal gap: 3,0 - 7,5  
 Packaging: 300 m x 2

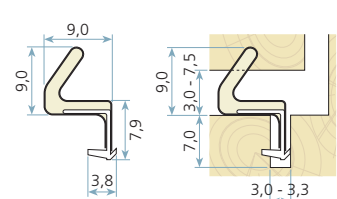

# For timber window and entry doors

## QL 3120

### Entry doors

Groove width:  
4,0 - 5,0  
Min. groove  
depth: 7,5  
Rebate: 12,0  
Seal gap: 5,0 - 7,5  
Packaging:  
200 m x 2

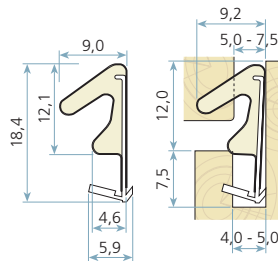

## QL 3123

### Windows

Groove width:  
4,0 - 5,0  
Min. groove  
depth: 7,5  
Rebate: 12,0  
Seal gap: 4,0 - 6,5  
Packaging:  
200 m x 2

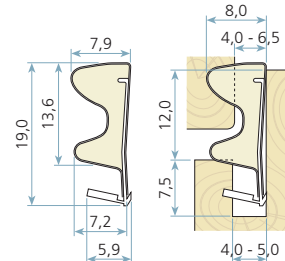

## QL 3128

### Windows

Groove width:  
2,7 - 3,0  
Min. groove  
depth: 7,0  
Rebate: 9,0  
Seal gap: 4,0 - 7,5  
Packaging:  
300 m x 2

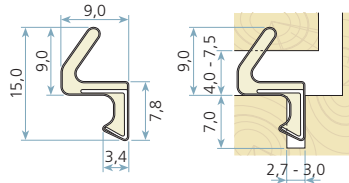

## QL 3131

### Windows

Groove width:  
2,7 - 3,0  
Min. groove  
depth: 8,0  
Rebate: 8,0  
Seal gap: 0,0 - 1,5  
Packaging:  
400 m x 2

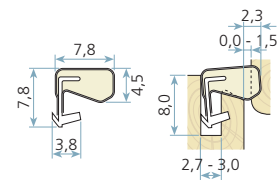

## QL 3133

### Windows

Groove width:  
2,7 - 3,0  
Min. groove  
depth: 6,0  
Rebate: 7,0  
Seal gap: 3,0 - 6,0  
Packaging:  
300 m x 2

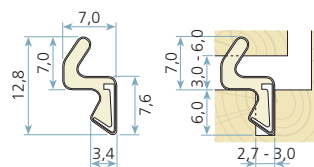

## QL 3135

### Windows

Groove width:  
2,7 - 3,0  
Min. groove  
depth: 6,5  
Rebate: 10,0  
Seal gap: 3,0 - 4,5  
Packaging:  
300 m x 2

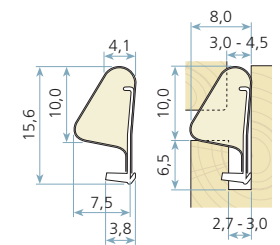

## QL 3136

### Windows

Groove width:  
2,7 - 3,2  
Min. groove  
depth: 6,5  
Rebate: 11,5  
Seal gap: 4,0 - 6,5  
Packaging:  
200 m x 2

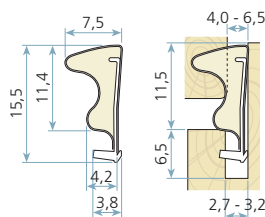

## QL 3139

### Windows

Groove width:  
3,0 - 3,3  
Min. groove  
depth: 7,0  
Rebate: 9,0  
Seal gap: 3,0 - 7,5  
Packaging:  
300 m x 2

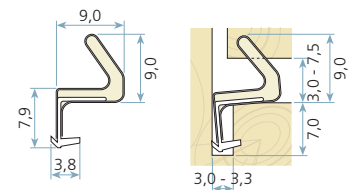

## QL 3140

### Windows

Groove width:  
4,0 - 5,0  
Min. groove  
depth: 7,5  
Rebate: 15,0  
Seal gap: 4,0 - 6,5  
Packaging:  
200 m x 2

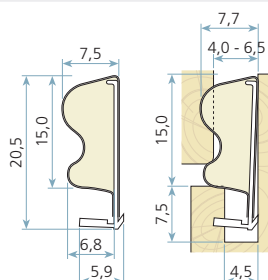

## QL 3141

### Windows

Groove width:  
2,7 - 3,2  
Min. groove  
depth: 5,5  
Rebate: 12,0  
Seal gap: 4,0 - 6,5  
Packaging:  
300 m x 2

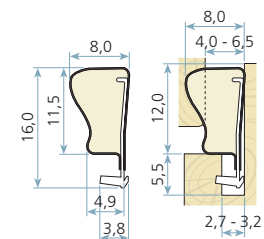

## For timber window and entry doors

### QL 4992

**C**  
**F**

#### Windows

Groove width:  
3,5 - 3,8  
Min. groove  
depth: 7,5  
Rebate: 10,0  
Seal gap: 3,5 - 5,5  
Packaging:  
200 m x 2

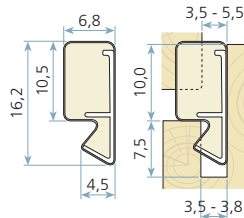

### QL 5271

**F**

#### Windows

Groove width:  
2,7 - 3,0  
Min. groove  
depth: 6,0  
Rebate: 11,0  
Seal gap: 2,4 - 3,8  
Packaging:  
250 m x 2

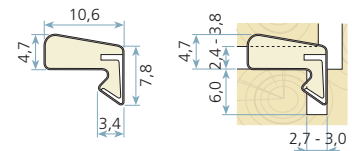

### QL 5694

#### Entry doors

Groove width:  
2,7 - 3,0  
Min. groove  
depth: 6,0  
Rebate: 10,0  
Seal gap: 6,0 - 11,0  
Packaging:  
200 m x 2 / 400 m x 1

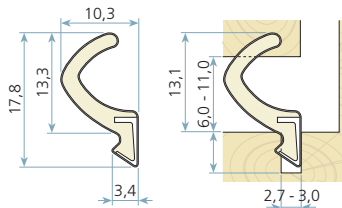

### QL 5878

**F**

#### Windows

Groove width:  
2,7 - 3,0  
Min. groove  
depth: 6,0  
Rebate: 10,0  
Seal gap: 3,2 - 4,9  
Packaging:  
250 m x 2

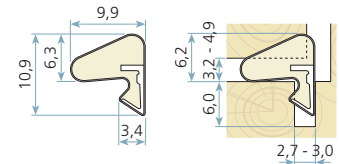

### QL 7000

#### Entry doors

Groove width:  
2,7 - 3,0  
Min. groove  
depth: 6,0  
Rebate: 13,0  
Seal gap: 4,0 - 10,8  
Packaging:  
175 m x 2

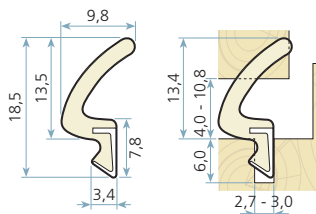

### QL 7066

#### Entry doors

Groove width:  
2,7 - 3,0  
Min. groove  
depth: 6,0  
Rebate: 10,0  
Seal gap: 4,8 - 7,7  
Packaging:  
400 m x 2 / 800 m x 2

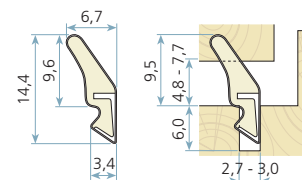

### QL 9111

#### Entry doors

Groove width:  
3,0 - 3,3  
Min. groove  
depth: 6,0  
Rebate: 12,0  
Seal gap: 4,8 - 7,9  
Packaging:  
300 m x 2

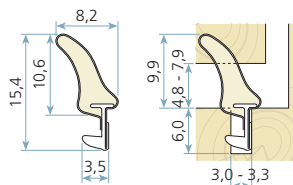

### QL 9985

**F**

#### Windows

Groove width:  
2,7 - 3,0  
Min. groove  
depth: 6,0  
Rebate: 10,0  
Seal gap: 3,0 - 6,5  
Packaging:  
250 m x 2

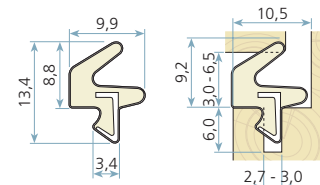



- Quick processing without corner cutting
- Not siliconised, neutral smell and no discolouration
- Low closing forces – low friction
- Available colours: white, black and grey. Other colours available on request



# Q-Lon Polyurethane Foam Seals: for PVC window and door and window covering product applications

**Specifically designed to meet the different demands of PVC casement windows, Schlegel Q-Lon foam seals maintain consistently high standards of energy efficiency, often exceeding any long-term window performance guarantees.**

The variety of flexible shapes and different colours makes these Q-Lon profiles particularly suited for sealing applications in window covering products such as roller shutters and screens. Fitted into PVC profiles, Q-Lon polyurethane foam seals generate noise dampening effects and help to minimise light and air leaks.

## Testing and results

Tested temperature range:	-60 °C to +70 °C
Heat conductivity:	0.06 W/mK at 0 °C
Compression force:	approx. 15 N at 25% compression per 100 mm, < 10 N for lip profiles
Compression set:	< 15% after 30 minutes relief of 50% compression at 70 °C and 24 hours (EN ISO 1856)
Weather resistance:	tested up to 20 years
Ozone resistance:	crack stage 0
Abrasion resistance:	no abrasion after 285,000 cycles of grinding load
Compatibility:	compatible with PVC-U, no crack formation in the contact material
Colour fastness:	no contact discolouration (colour fastness index >4)



## For PVC applications

### QL 4465

Doors / Windows  
Pocket-Slot

Throat width: 4,2  
Seal gap: 3,0 - 4,8  
Packaging:  
250 m x 2

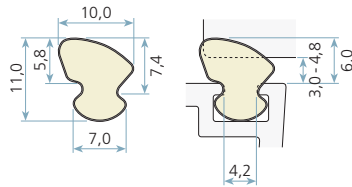

### QL 4627

Windows  
Pocket-Slot  
T-Slot  
Type A (5,3 mm)

Throat width: 3,2  
Seal gap: 0,5 - 2,0  
Packaging:  
300 m x 2

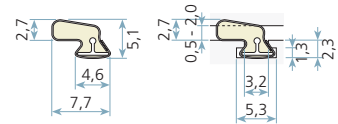

### QL 5570

Windows  
Pocket-Slot

Throat width: 3,3  
Seal gap: 3,0 - 4,8  
Packaging:  
250 m x 2

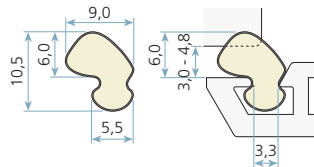

### QL 5985

Windows  
Pocket-Slot

Throat width: 4,0  
Seal gap: 2,3 - 3,6  
Packaging:  
250 m x 2

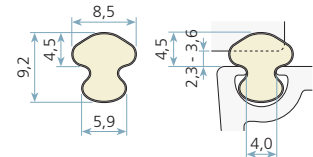

### QL 6436

Windows  
Pocket-Slot

Throat width: 3,5  
Seal gap: 2,6 - 4,2  
Packaging:  
300 m x 2

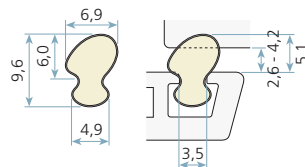

### QL 6493

Windows  
Pocket-Slot

Throat width: 3,6  
Seal gap: 2,0 - 3,0  
Packaging:  
300 m x 2

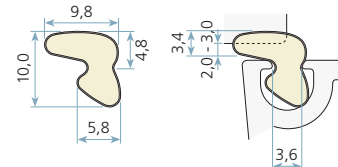

### QL 6517

Windows  
Pocket-Slot

Throat width: 3,5  
Seal gap: 1,9 - 3,2  
Packaging:  
300 m x 2

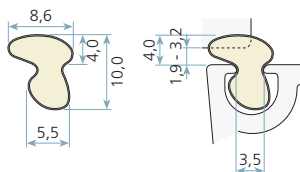

### QL 6571

Windows  
Pocket-Slot

Throat width: 3,0  
Seal gap: 3,0 - 5,0  
Packaging:  
250 m x 2

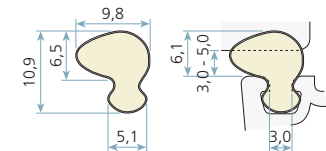

### QL 6750

Windows  
Pocket-Slot

Throat width: 2,5  
Seal gap: 2,6 - 4,1  
Packaging:  
300 m x 2

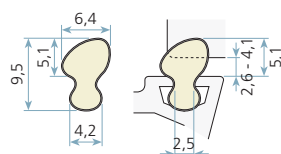

### QL 6991

Windows  
Pocket-Slot

Throat width: 3,9  
Seal gap: 2,0 - 3,2  
Packaging:  
250 m x 2 / 300 m x 2

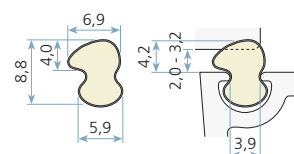

## For PVC applications

### QL 7032

Doors / Windows  
Pocket-Slot

Throat width: 3,0

Seal gap: 1,5 - 5,1

Packaging:  
200 m x 2 / 400 m x 2

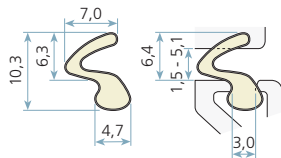

### QL 7307

Windows  
Pocket-Slot

Throat width: 3,2

Seal gap: 2,8 - 4,4

Packaging:  
250 m x 2

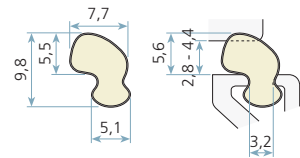

### QL 9005

Windows  
Pocket-Slot

Throat width: 2,4

Seal gap: 2,5 - 4,1

Packaging:  
100 m x 2 / 300 m x 2  
400 m x 2

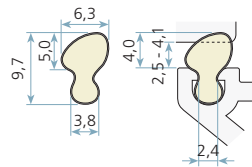

### QL 9100

Windows  
Pocket-Slot

Throat width: 2,4

Seal gap: 2,7 - 4,4

Packaging:  
250 m x 2

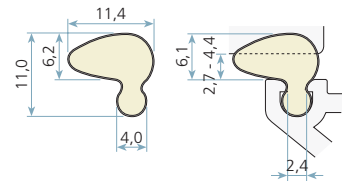

### QL 9106

Windows  
Pocket-Slot

Throat width: 3,2

Seal gap: 1,5 - 5,6

Packaging:  
250 m x 2

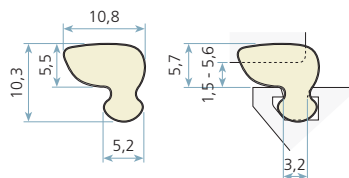

### QL 9107

Doors / Windows  
Pocket-Slot

Throat width: 3,2

Seal gap: 1,5 - 5,6

Packaging:  
200 m x 2 / 400 m x 2  
800 m x 2

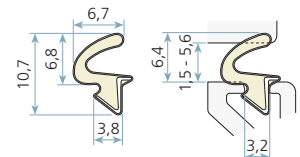

### QL 9112

Windows  
Pocket-Slot

Throat width: 3,2

Seal gap: 3,0 - 4,9

Packaging:  
300 m x 2

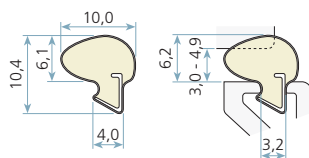

### QL 9113

Windows  
Pocket-Slot

Throat width: 2,4

Seal gap: 2,8 - 4,6

Packaging:  
400 m x 2

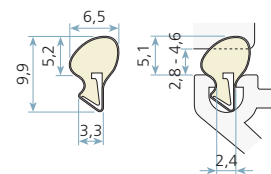

### QL 9154

Windows  
Pocket-Slot

Throat width: 3,2

Seal gap: 2,8 - 4,5

Packaging:  
300 m x 2 / 600 m x 1

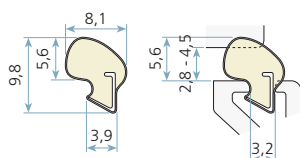

### QL 9257

Doors / Windows  
Pocket-Slot

Throat width: 3,2

Seal gap: 4,5 - 7,1

Packaging:  
300 m x 2

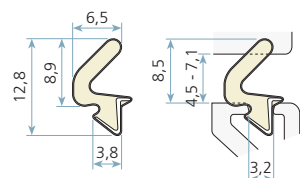

## For PVC applications

### QL 9296

Windows  
Pocket-Slot

Throat width: 3,2  
Seal gap: 4,0 - 7,5  
Packaging:  
250 m x 2

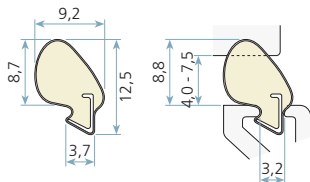

### QL 9489

Doors / Windows  
Pocket-Slot

Throat width: 3,4  
Seal gap: 2,5 - 4,0  
Packaging:  
250 m x 2

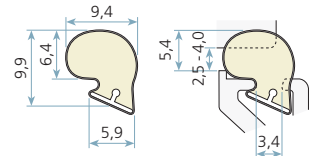

### QL 9536

Doors  
Pocket-Slot

Throat width: 3,9  
Seal gap: 4,0 - 8,0  
Packaging:  
250 m x 2

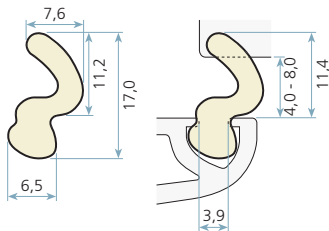

### QL 9596

Windows  
Pocket-Slot

Throat width: 3,4  
Seal gap: 2,5 - 4,0  
Packaging:  
300 m x 2

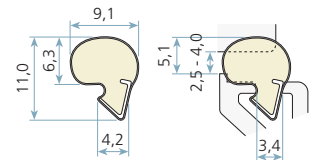

### QL 9646

Windows  
Pocket-Slot

Throat width: 3,6  
Seal gap: 3,5 - 5,5  
Packaging:  
250 m x 2

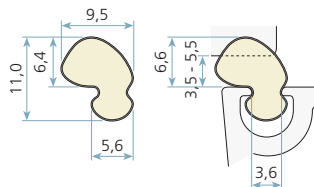

### QL 9688

Doors / Windows  
Pocket-Slot

Throat width: 2,8  
Seal gap: 3,0 - 7,0  
Packaging:  
400 m x 2

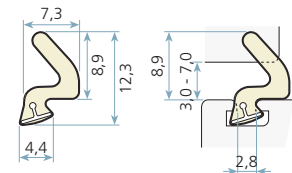

### QL 9710

Windows  
Pocket-Slot

Throat width: 3,3  
Seal gap: 3,0 - 5,5  
Packaging:  
300 m x 2

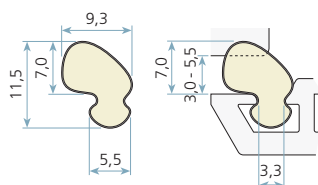

### QL 9756

Windows  
Pocket-Slot

Throat width: 3,3  
Seal gap: 1,0 - 4,8  
Packaging:  
300 m x 2

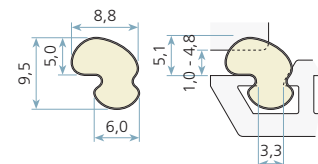

### QL 9762

Windows  
Pocket-Slot

Throat width: 3,2  
Seal gap: 2,5 - 4,0  
Packaging:  
300 m x 2 / 700 m x 2

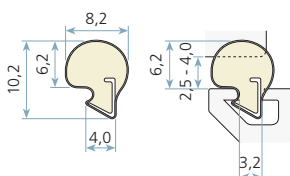

### QL 9898

Windows  
Pocket-Slot

Throat width: 3,2  
Seal gap: 3,0 - 5,5  
Packaging:  
300 m x 2 / 700 m x 2

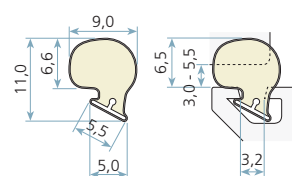

## For PVC applications

### QL 9926

Doors / Windows  
Pocket-Slot

Throat width:  
3,2 - 3,4

Seal gap: 3,0 - 7,5

Packaging:  
300 m x 2

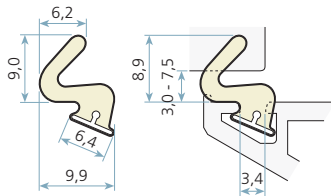

### QL 9928

Doors / Windows  
Pocket-Slot

Throat width:  
3,2 - 3,4

Seal gap: 3,0 - 7,5

Packaging:  
300 m x 2

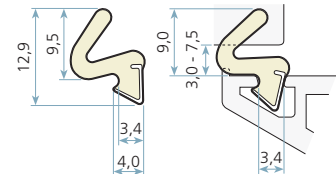

### QL 9979

Doors / Windows  
Pocket-Slot

Throat width:  
3,0 - 3,5

Seal gap: 3,0 - 7,0

Packaging:  
250 m x 2

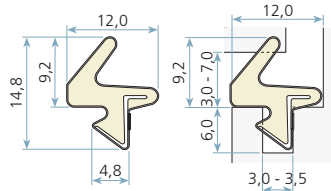

### QL 48400

Windows  
T-Slot  
Type A (5,3 mm)

Throat width: 3,2

Groove depth: 2,3

Seal gap: 0,5 - 1,5

Packaging:  
200 m x 2 / 700 m x 2  
900 m x 2

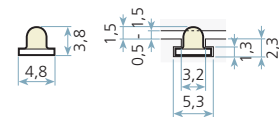

### QL 48447

Doors / Windows  
T-Slot  
Type A (5,3 mm)

Throat width: 3,2

Groove depth: 2,3

Seal gap: 2,5 - 7,0

Packaging:  
250 m x 2

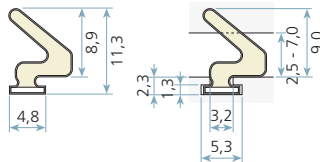

### QL 48510

Windows  
T-Slot  
Type A (5,3 mm)

Throat width: 3,2

Groove depth: 2,3

Seal gap: 1,1 - 2,4

Packaging:  
200 m x 2 / 500 m x 2  
900 m x 2

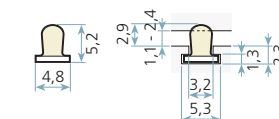

### QL 48650

Windows  
T-Slot  
Type A (5,3 mm)

Throat width: 3,2

Groove depth: 2,3

Seal gap: 1,8 - 3,4

Packaging:  
200 m x 2 / 500 m x 2  
700 m x 2

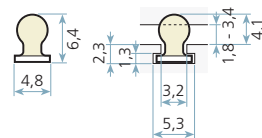

### QL 48700

Doors / Windows  
T-Slot  
Type A (5,3 mm)

Throat width: 3,2

Groove depth: 2,3

Seal gap: 2,5 - 6,0

Packaging:  
250 m x 2

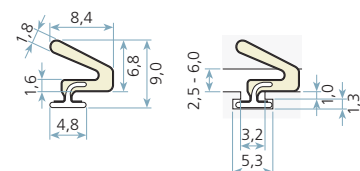

### QL 48750

Windows  
T-Slot  
Type A (5,3 mm)

Throat width: 3,2

Groove depth: 2,3

Seal gap: 2,7 - 4,6

Packaging:  
200 m x 2 / 600 m x 2

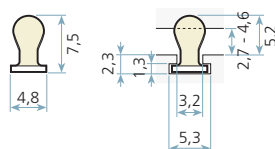

### QL 48800

Doors / Windows  
T-Slot  
Type A (5,3 mm)

Throat width: 3,2

Groove depth: 2,3

Seal gap: 2,5 - 7,0

Packaging:  
250 m x 2

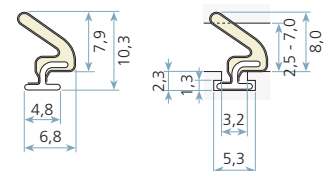

# For PVC applications

## QL 48950

Doors / Windows  
T-Slot  
Type A (5,3 mm)  
Throat width: 3,2  
Groove depth: 2,3  
Seal gap: 4,0 - 6,5  
Packaging:  
200 m x 2 / 500 m x 2

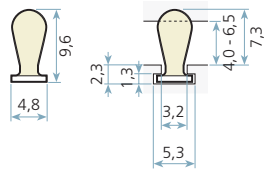

## QL 57700

Windows  
T-Slot  
Type B (6,3 mm)  
Throat width: 3,8  
Groove depth: 2,3  
Seal gap: 2,3 - 4,0  
Packaging:  
200 m x 2 / 500 m x 2

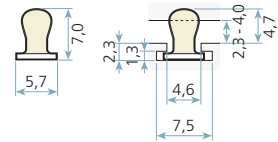

## QL 69400

Windows  
T-Slot  
Type C (7,5 mm)  
Throat width: 4,6  
Groove depth: 2,3  
Seal gap: 0,5 - 1,5  
Packaging:  
200 m x 2 / 700 m x 2  
900 m x 2

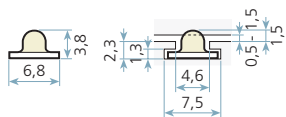

## QL 69447

Doors / Windows  
T-Slot  
Type C (7,5 mm)  
Throat width: 4,6  
Groove depth: 2,3  
Seal gap: 2,5 - 7,0  
Packaging:  
250 m x 2

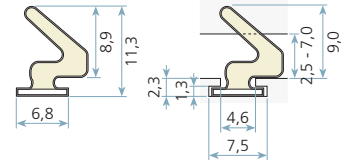

## QL 69510

Windows  
T-Slot  
Type C (7,5 mm)  
Throat width: 4,6  
Groove depth: 2,3  
Seal gap: 1,1 - 2,4  
Packaging:  
700 m x 2

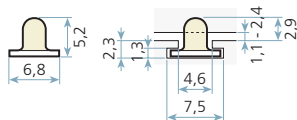

## QL 69650

Windows  
T-Slot  
Type C (7,5 mm)  
Throat width: 4,6  
Groove depth: 2,3  
Seal gap: 1,8 - 3,4  
Packaging:  
200 m x 2 / 400 m x 2  
600 m x 2

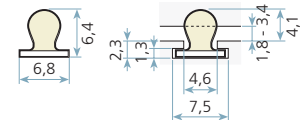

## QL 69750

Windows  
T-Slot  
Type C (7,5 mm)  
Throat width: 4,6  
Groove depth: 2,3  
Seal gap: 2,7 - 4,6  
Packaging:  
200 m x 2 / 500 m x 2

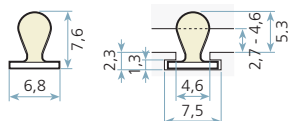

## QL 69800

Doors / Windows  
T-Slot  
Type C (7,5 mm)  
Throat width: 4,6  
Groove depth: 2,3  
Seal gap: 2,5 - 7,0  
Packaging:  
250 m x 2

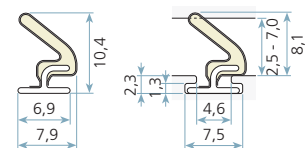

## QL 69950

Doors / Windows  
T-Slot  
Type C (7,5 mm)  
Throat width: 4,6  
Groove depth: 2,3  
Seal gap: 4,0 - 6,5  
Packaging:  
200 m x 2 / 350 m x 2

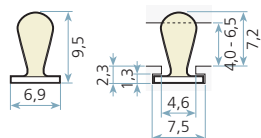

## T-Slot dimensions

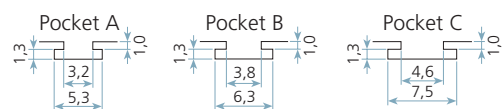

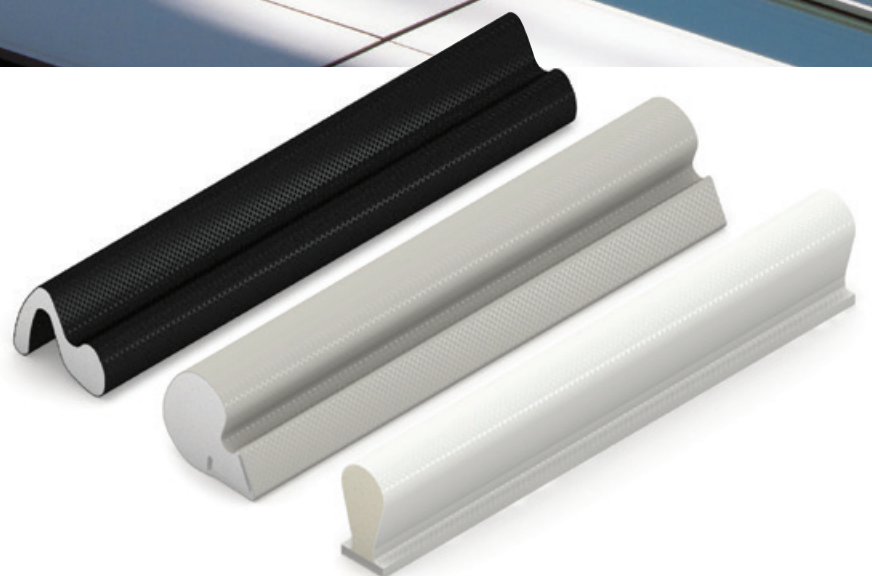



- Exceptional performance maintained over a wide temperature range
- Lower insertion forces speed up fitting by 15%
- Compensates for window movement
- Available colours: white, black and grey. Other colours available on request



# Q-Lon Polyurethane Foam Seals:

## for aluminium window and door and window covering product applications

**Specially designed to meet the different demands of aluminium windows and doors, Q-Lon polyurethane foam seals have excellent compression recovery of 99%, giving constant height at corners for improved weathering. With the rigid insert, Q-Lon seals eliminate any risk of shrink back that would compromise the weathering performance of the window or door.**

The variety of flexible shapes and different colours makes these Q-Lon profiles particularly suited for sealing applications in window covering products such as roller shutters and screens. Fitted into aluminium head boxes, side guiding channels or bottom bars, Q-Lon polyurethane foam seals minimise light and air leaks, limit contamination and provide long lasting noise dampening effects.

### Testing and results

Tested temperature range:	-60 °C to +70 °C
Heat conductivity:	0.06 W/mK at 0 °C
Compression force:	approx. < 15 N /100 mm, < 10 N/100 mm for lip seals
Compression set:	< 15% after 30 minutes relief of 50% compression at 70 °C and 24 hours (EN ISO 1856)
Weather resistance:	tested up to 20 years
Ozone resistance:	crack stage 0
Abrasion resistance:	no abrasion after in excess of 100,000 cycles with no failure mode
Colour fastness:	no contact discolouration (colour fastness index > 4)
Controls:	manufactured in accordance with ISO 9001



## For aluminium applications

### QL 4627

Windows / Other  
T-Slot

Type A (5,3 mm)

Throat width: 3,2

Groove depth: 2,3

Seal gap: 0,5 - 2,0

Packaging:

300 m x 2

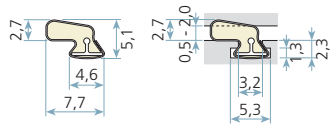

### QL 48400

Windows / Other  
T-Slot

Type A (5,3 mm)

Throat width: 3,2

Groove depth: 2,3

Seal gap: 0,5 - 1,5

Packaging:

200 m x 2 / 700 m x 2

900 m x 2

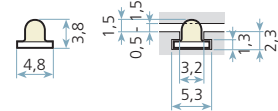

### QL 48447

Windows / Doors /  
Other  
T-Slot

Type A (5,3 mm)

Throat width: 3,2

Groove depth: 2,3

Seal gap: 2,5 - 7,0

Packaging:

250 m x 2

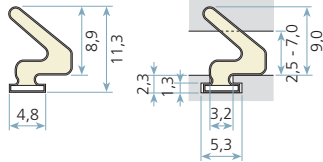

### QL 48510

Windows / Other  
T-Slot

Type A (5,3 mm)

Throat width: 3,2

Groove depth: 2,3

Seal gap: 1,1 - 2,4

Packaging:

200 m x 2 / 500 m x 2

900 m x 2

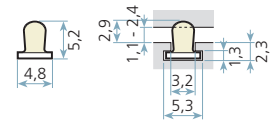

### QL 48650

Windows / Other  
T-Slot

Type A (5,3 mm)

Throat width: 3,2

Groove depth: 2,3

Seal gap: 1,8 - 3,4

Packaging:

200 m x 2 / 500 m x 2

700 m x 2

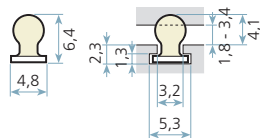

### QL 48700

Windows / Doors /  
Other  
T-Slot

Type A (5,3 mm)

Throat width: 3,2

Groove depth: 2,3

Seal gap: 2,5 - 6,0

Packaging:

250 m x 2

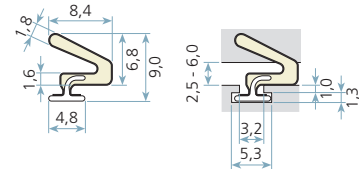

### QL 48750

Windows / Other  
T-Slot

Type A (5,3 mm)

Throat width: 3,2

Groove depth: 2,3

Seal gap: 2,7 - 4,6

Packaging:

200 m x 2 / 600 m x 2

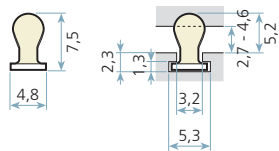

### QL 48800

Windows / Doors /  
Other  
T-Slot

Type A (5,3 mm)

Throat width: 3,2

Groove depth: 2,3

Seal gap: 2,5 - 7,0

Packaging:

250 m x 2

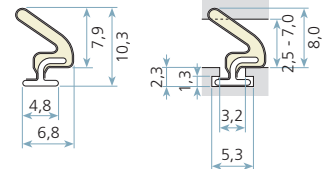

### QL 48950

Windows / Doors /  
Other  
T-Slot

Type A (5,3 mm)

Throat width: 3,2

Groove depth: 2,3

Seal gap: 4,0 - 6,5

Packaging:

200 m x 2 / 500 m x 2

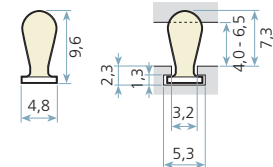

### QL 57700

Windows / Other  
T-Slot

Type B (6,3 mm)

Throat width: 3,8

Groove depth: 2,3

Seal gap: 2,3 - 4,0

Packaging:

200 m x 2 / 500 m x 2

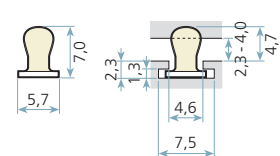

## For aluminium applications

### QL 69400

Windows / Other  
T-Slot

Type C (7,5 mm)

Throat width: 4,6

Groove depth: 2,3

Seal gap: 0,5 - 1,5

Packaging:

200 m x 2 / 700 m x 2

900 m x 2

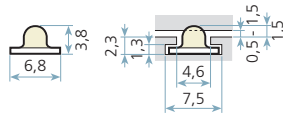

### QL 69447

Windows / Doors /  
Other

T-Slot

Type C (7,5 mm)

Throat width: 4,6

Groove depth: 2,3

Seal gap: 2,5 - 7,0

Packaging:

250 m x 2

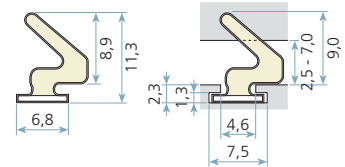

### QL 69510

Windows / Other  
T-Slot

Type C (7,5 mm)

Throat width: 4,6

Groove depth: 2,3

Seal gap: 1,1 - 2,4

Packaging:

700 m x 2

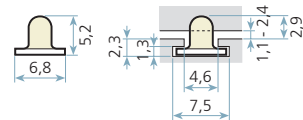

### QL 69650

Windows / Other  
T-Slot

Type C (7,5 mm)

Throat width: 4,6

Groove depth: 2,3

Seal gap: 1,8 - 3,4

Packaging:

200 m x 2 / 400 m x 2

600 m x 2

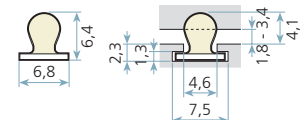

### QL 69750

Windows / Other  
T-Slot

Type C (7,5 mm)

Throat width: 4,6

Groove depth: 2,3

Seal gap: 2,7 - 4,6

Packaging:

200 m x 2 / 500 m x 2

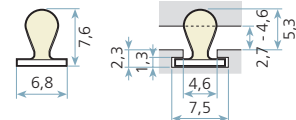

### QL 69800

Windows / Doors /  
Other

T-Slot

Type C (7,5 mm)

Throat width: 4,6

Groove depth: 2,3

Seal gap: 2,5 - 7,0

Packaging:

250 m x 2

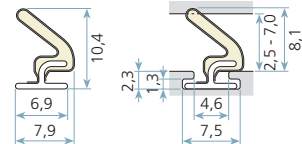

### QL 69950

Windows / Doors /  
Other

T-Slot

Type C (7,5 mm)

Throat width: 4,6

Groove depth: 2,3

Seal gap: 4,0 - 6,5

Packaging:

200 m x 2 / 350 m x 2

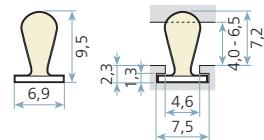

### T-Slot dimensions

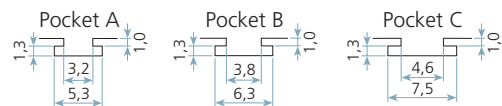



- Suitable for internal timber doors and sliding wardrobe, closet and sideboard doors
- Helps to reduce noise, dust and light contamination
- Available colours: white, black, bronze and grey. Other colours available on request

# Q-Lon Polyurethane Foam Seals:

## for interior design; internal door and furniture applications

Internal door and sliding door furniture seals are used as extra insulation to prevent air, dust, light and other contaminants from entering the gaps. The product is attached to the door frame creating a seal when the door is closed.

### Testing and results

Compression set:	< 15% after 1 hour relief of 50% compression at 70 °C and 24 hours. (DIN 53572)
Compression force:	approx. 15 N at 25% compression per 100 mm, < 10 N for lip profiles
Tested temperature range:	-60 °C to +70 °C
Heat conductivity:	0.06 W/mK at 0 °C
Long life performance:	no change of the length-related and partial joint permeability
Paint compatibility:	no adhesion, no hardening, no discolouration
Weather-resistant:	tested up to 20 years

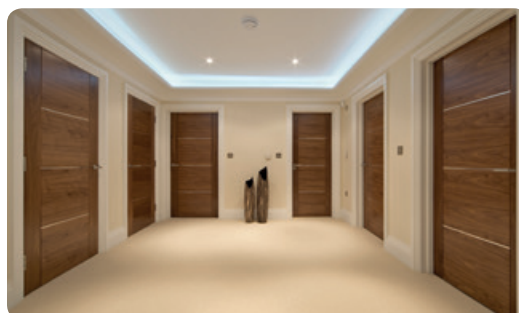

# For interior design

## QL 50

Internal doors / Furniture

Groove width: 2,7 - 3,0  
 Min. groove depth: 6,0  
 Rebate: 10,0  
 Seal gap: 3,0 - 5,0  
 Packaging: 250 m x 2

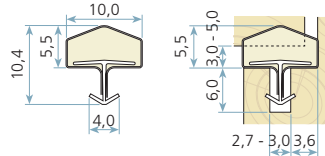

## QL 55

Internal doors / Furniture

Groove width: 2,7 - 3,0  
 Min. groove depth: 6,0  
 Rebate: 10,0  
 Seal gap: 3,0 - 4,5  
 Packaging: 250 m x 2

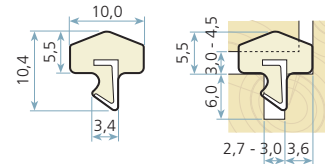

## QL 60

Internal doors / Furniture

Groove width: 2,7 - 3,0  
 Min. groove depth: 6,0  
 Rebate: 10,0  
 Seal gap: 3,0 - 4,5  
 Packaging: 250 m x 2

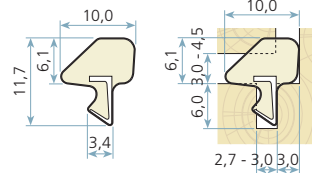

## QL 650

Internal doors / Furniture

Groove width: 2,7 - 3,0  
 Min. groove depth: 6,0  
 Rebate: 13,5  
 Seal gap: 8,0 - 15,0  
 Packaging: 2,1 m x 150

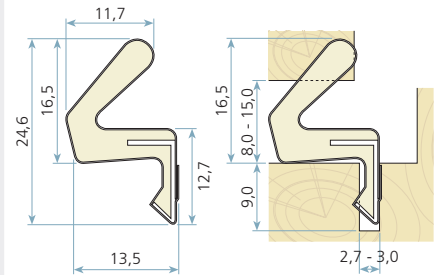

## QL 836

Furniture

Groove width: 3,0 - 3,2  
 Min. groove depth: 7,5  
 Seal gap: 5,0 - 7,5  
 Packaging: 125 m x 2

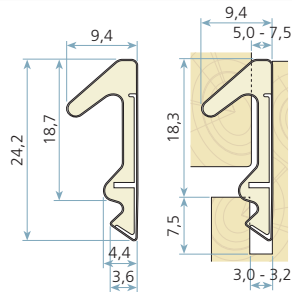

## QL 3004

Furniture

Groove width: 2,7 - 3,0  
 Min. groove depth: 6,0  
 Seal gap: 3,0 - 5,0  
 Packaging: 350 m x 2

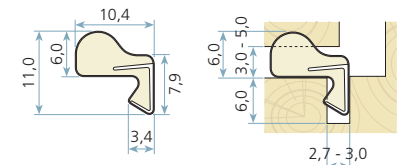

## QL 3005

Furniture

Groove width: 2,7 - 3,0  
 Min. groove depth: 6,0  
 Seal gap: 3,4 - 5,4  
 Packaging: 300 m x 2

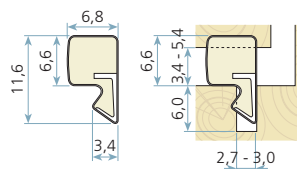

## QL 3006

Furniture

Groove width: 2,7 - 3,0  
 Min. groove depth: 6,0  
 Seal gap: 5,0 - 13,0  
 Packaging: 2,1 m x 150

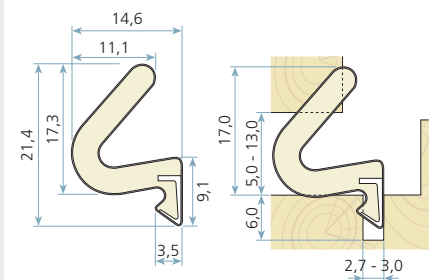

## QL 3009

Furniture

Groove width: 2,7 - 3,0  
 Min. groove depth: 6,0  
 Seal gap: 4,0 - 7,5  
 Packaging: 250 m x 2

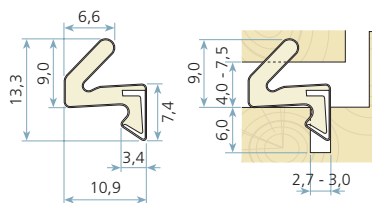

## QL 3011

Furniture

Groove width: 2,7 - 3,0  
 Min. groove depth: 6,0  
 Seal gap: 3,5 - 5,5  
 Packaging: 250 m x 2

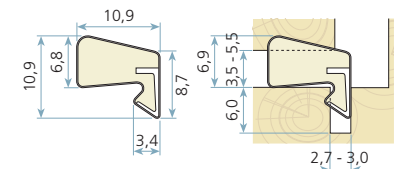

## For interior design

### QL 3012

#### Furniture

Groove width:  
2,7 - 3,0

Min. groove  
depth: 6,0

Seal gap: 4,0 - 6,5

Packaging:  
200 m x 2

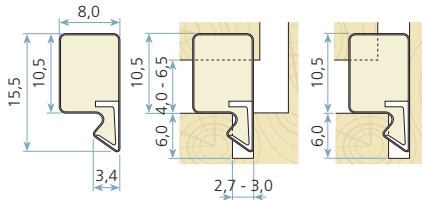

### QL 3013

#### Furniture

Groove width:  
2,7 - 3,0

Min. groove  
depth: 6,0

Seal gap: 2,0 - 3,0

Packaging:  
500 m x 2

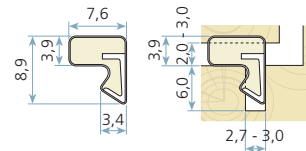

### QL 3034

#### Furniture

Groove width:  
2,7 - 3,0

Min. groove  
depth: 8,0

Seal gap: 0,0 - 1,5

Packaging:  
400 m x 2

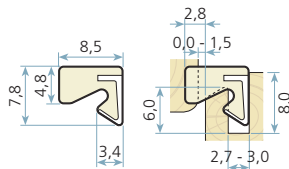

### QL 3037

#### Internal doors / Furniture

Groove width:  
2,7 - 3,0

Min. groove  
depth: 6,0

Rebate: 10,0

Seal gap: 3,5 - 5,6

Packaging:  
200 m x 2

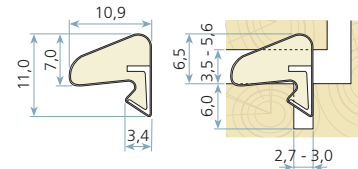

### QL 3070

#### Furniture

Groove width:  
2,7 - 3,0

Min. groove  
depth: 8,0

Seal gap: 0,0 - 1,5

Packaging:  
400 m x 2

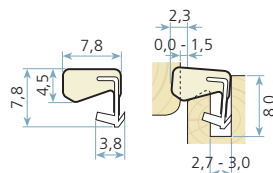

### QL 3072

#### Internal doors / Furniture

Groove width:  
2,7 - 3,2

Min. groove  
depth: 6,5

Rebate: 10,0

Seal gap: 2,7 - 4,3

Packaging:  
300 m x 2

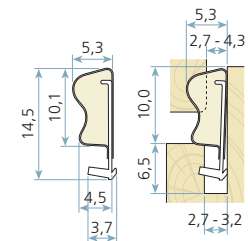

### QL 3073

#### Furniture

Groove width:  
4,0 - 5,0

Min. groove  
depth: 7,5

Seal gap: 5,0 - 8,0

Packaging:  
150 m x 2 / 200 m x 2

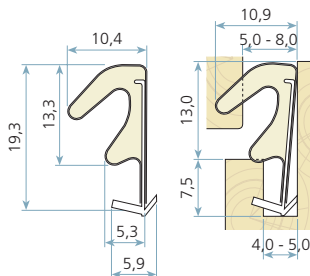

### QL 3074

#### Furniture

Groove width:  
2,7 - 3,2

Min. groove  
depth: 6,5

Seal gap: 3,5 - 5,5

Packaging:  
300 m x 2

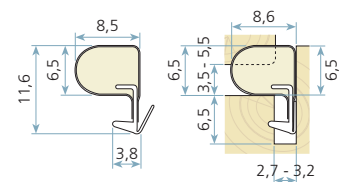

### QL 3077

#### Furniture

Groove width:  
2,7 - 3,0

Min. groove  
depth: 6,0

Seal gap: 2,0 - 3,0

Packaging:  
500 m x 2

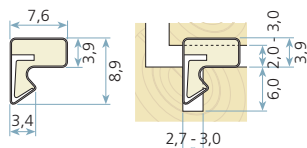

### QL 3078

#### Furniture

Groove width:  
3,0 - 3,3

Min. groove  
depth: 6,0

Seal gap: 4,0 - 7,5

Packaging:  
250 m x 2 / 300 m x 2

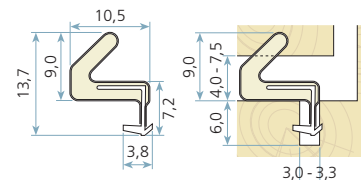

## For interior design

### QL 3079

#### Furniture

Groove width:  
3,2 - 4,0

Min. groove  
depth: 6,5

Seal gap: 2,7 - 4,3

Packaging:  
300 m x 2

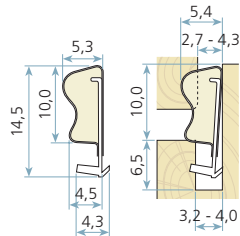

### QL 3091

#### Internal doors / Furniture

Groove width:  
4,0 - 5,0

Min. groove  
depth: 7,5

Seal gap: 4,0 - 8,0

Packaging:  
150 m x 2 / 400 m x 1

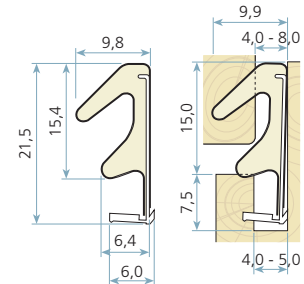

### QL 3093

#### Furniture

Groove width:  
2,7 - 3,0

Min. groove  
depth: 7,0

Seal gap: 4,0 - 8,0

Packaging:  
150 m x 2 / 400 m x 1

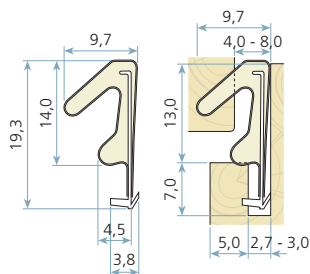

### QL 3094

#### Internal doors / Furniture

Groove width:  
2,7 - 3,2

Min. groove  
depth: 6,5

Rebate: 10,0

Seal gap: 3,0 - 6,0

Packaging:  
250 m x 2

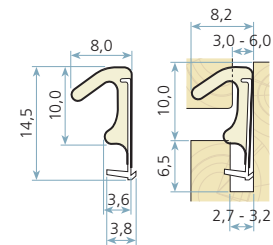

### QL 3095

#### Furniture

Groove width:  
3,5 - 4,0

Min. groove  
depth: 6,5

Seal gap: 3,0 - 6,0

Packaging:  
250 m x 2

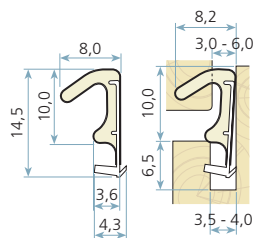

### QL 3096

#### Furniture

Groove width:  
4,0 - 5,0

Min. groove  
depth: 7,5

Seal gap: 3,0 - 6,0

Packaging:  
200 m x 2

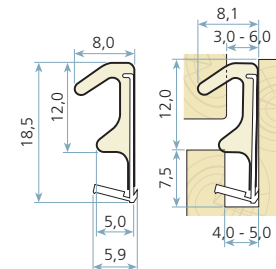

### QL 3098

#### Furniture

Groove width:  
3,0 - 4,0

Min. groove  
depth: 7,5

Seal gap: 3,0 - 6,0

Packaging:  
150 m x 2

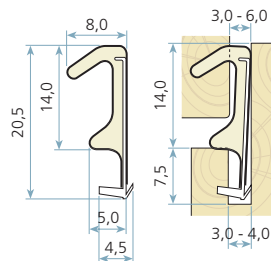

### QL 3099

#### Furniture

Groove width:  
3,0 - 3,3

Min. groove  
depth: 6,0

Seal gap: 4,0 - 7,5

Packaging:  
250 m x 2 / 300 m x 2

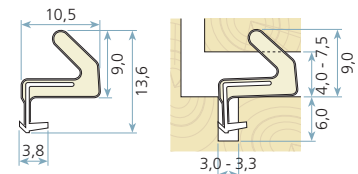

### QL 3100

#### Internal doors / Furniture

Groove width:  
3,5 - 4,0

Min. groove  
depth: 6,5

Rebate: 12,0

Seal gap: 4,0 - 7,5

Packaging:  
200 m x 2

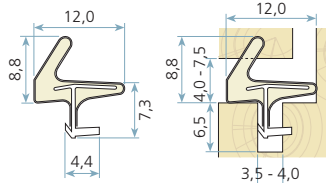

### QL 3102

#### Furniture

Groove width:  
3,7 - 4,2

Min. groove  
depth: 7,0

Seal gap: 5,0 - 7,5

Packaging:  
200 m x 2

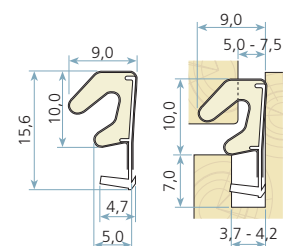



## For interior design

### QL 3104

#### Furniture

Groove width:  
4,0 - 5,0  
Min. groove  
depth: 7,5  
Seal gap: 5,0 - 9,0  
Packaging:  
200 m x 2

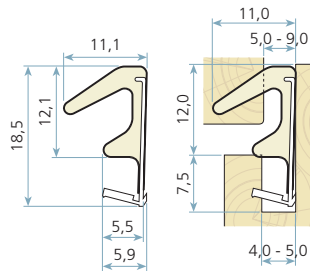

### QL 3106

#### Internal doors / Furniture

Groove width:  
3,5 - 4,0  
Min. groove  
depth: 6,5  
Rebate: 12,0  
Seal gap: 3,0 - 5,0  
Packaging:  
250 m x 2

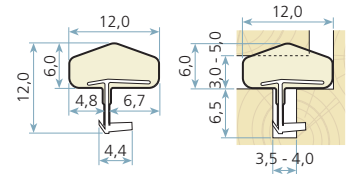

### QL 3109

#### Furniture

Groove width:  
4,0 - 5,0  
Min. groove  
depth: 7,0  
Seal gap: 5,0 - 9,0  
Packaging:  
100 m x 2

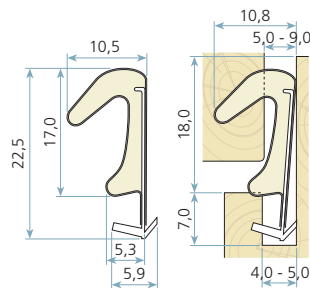

### QL 3110

#### Internal doors / Furniture

Groove width:  
3,5 - 4,0  
Min. groove  
depth: 6,5  
Rebate: 12,0  
Seal gap: 3,5 - 4,0  
Packaging:  
150 m x 2

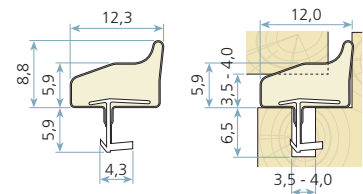

### QL 3113

#### Internal doors / Furniture

Groove width:  
3,5 - 4,0  
Min. groove  
depth: 7,0  
Rebate: 12,0  
Seal gap: 4,0 - 7,5  
Packaging:  
200 m x 2

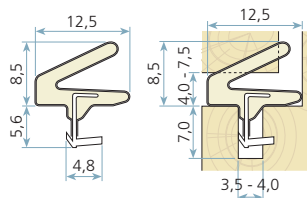

### QL 3118

#### Furniture

Groove width:  
3,0 - 3,3  
Min. groove  
depth: 7,0  
Seal gap: 3,0 - 7,5  
Packaging:  
300 m x 2

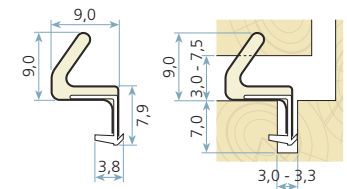

### QL 3120

#### Furniture

Groove width:  
4,0 - 5,0  
Min. groove  
depth: 7,5  
Seal gap: 5,0 - 7,5  
Packaging:  
200 m x 2

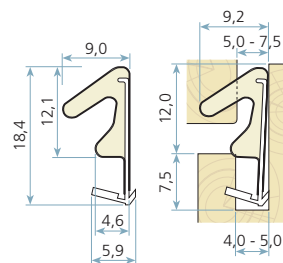

### QL 3128

#### Furniture

Groove width:  
2,7 - 3,0  
Min. groove  
depth: 7,0  
Seal gap: 4,0 - 7,5  
Packaging:  
300 m x 2

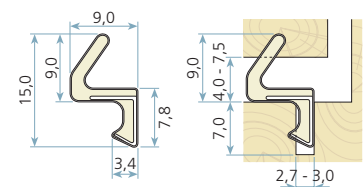

### QL 3131

#### Furniture

Groove width:  
2,7 - 3,0  
Min. groove  
depth: 8,0  
Seal gap: 0,0 - 1,5  
Packaging:  
400 m x 2

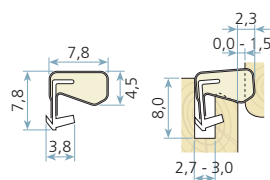

### QL 3133

#### Furniture

Groove width:  
2,7 - 3,0  
Min. groove  
depth: 6,0  
Seal gap: 3,0 - 6,0  
Packaging:  
300 m x 2

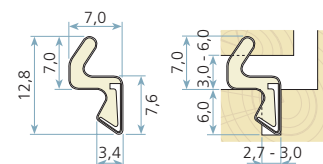

## For interior design

### QL 3137

#### Internal doors / Furniture

Groove width: 2,7 - 3,2  
 Min. groove depth: 6,0  
 Rebate: 10,0  
 Seal gap: 3,0 - 4,5  
 Packaging: 250 m x 2

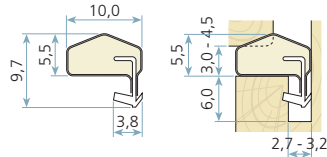

### QL 3138

#### Internal doors / Furniture

Groove width: 2,7 - 3,2  
 Min. groove depth: 6,0  
 Rebate: 8,0  
 Seal gap: 3,0 - 4,5  
 Packaging: 250 m x 2

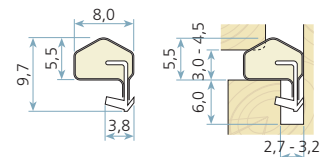

### QL 3139

#### Furniture

Groove width: 3,0 - 3,3  
 Min. groove depth: 7,0  
 Seal gap: 3,0 - 7,5  
 Packaging: 300 m x 2

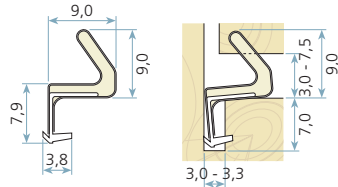

### QL 5626

#### Furniture

Groove width: 2,7 - 3,0  
 Min. groove depth: 6,0  
 Seal gap: 4,7 - 7,5  
 Packaging: 300 m x 2

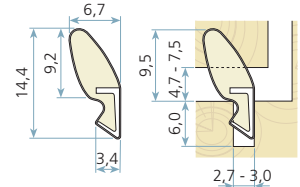

### QL 5694

#### Furniture

Groove width: 2,7 - 3,0  
 Min. groove depth: 6,0  
 Seal gap: 6,0 - 11,0  
 Packaging: 200 m x 2 / 400 m x 1

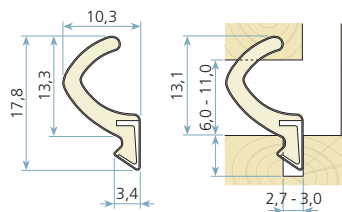

### QL 7000

#### Furniture

Groove width: 2,7 - 3,0  
 Min. groove depth: 6,0  
 Seal gap: 4,0 - 10,8  
 Packaging: 175 m x 2

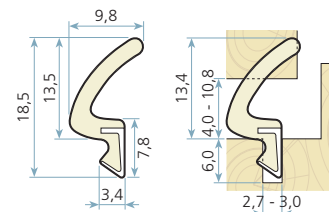

### QL 7066

#### Furniture

Groove width: 2,7 - 3,0  
 Min. groove depth: 6,0  
 Seal gap: 4,8 - 7,7  
 Packaging: 400 m x 2 / 800 m x 2

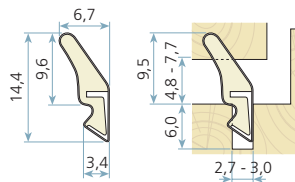

### QL 9111

#### Furniture

Groove width: 3,0 - 3,3  
 Min. groove depth: 6,0  
 Seal gap: 4,8 - 7,9  
 Packaging: 300 m x 2

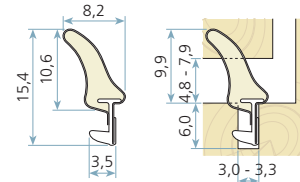

## For interior design

### QL 9915

Internal doors /  
Furniture

Groove width:  
2,7 - 3,0

Min. groove  
depth: 6,0

Rebate: 11,0

Seal gap: 2,5 - 4,5

Packaging:  
300 m x 2

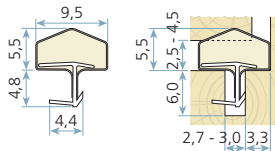

### QL 9921

Internal doors /  
Furniture

Groove width:  
2,7 - 3,0

Min. groove  
depth: 6,0

Rebate: 10,0

Seal gap: 3,0 - 5,0

Packaging:  
250 m x 2

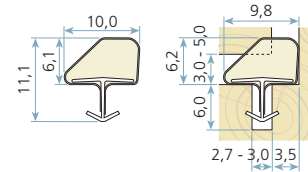

### QL 9931

Internal doors /  
Furniture

Groove width:  
3,0 - 3,5

Min. groove  
depth: 6,5

Rebate: 12,0

Seal gap: 3,5 - 4,0

Packaging:  
200 m x 2

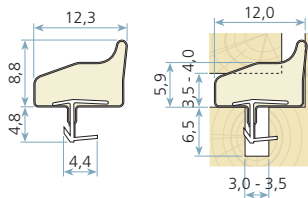

### QL 9979

Furniture

Groove width:  
3,0 - 3,5

Min. groove  
depth: 6,0

Seal gap: 3,0 - 7,0

Packaging:  
250 m x 2

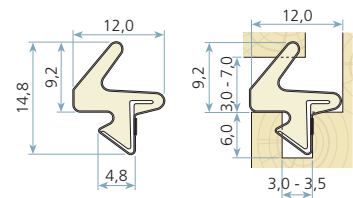

### QL 9985

Internal doors /  
Furniture

Groove width:  
2,7 - 3,0

Min. groove  
depth: 6,0

Rebate: 10,0

Seal gap: 3,0 - 6,5

Packaging:  
250 m x 2

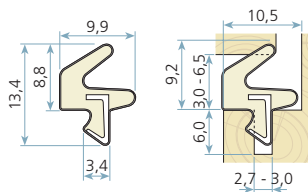

# Accessories and Tools: for Q-Lon polyurethane foam seals

## Q-Lon cover caps for French windows

Special colour co-ordinated caps made from resistant HDPE for various groove and rebate dimensions.

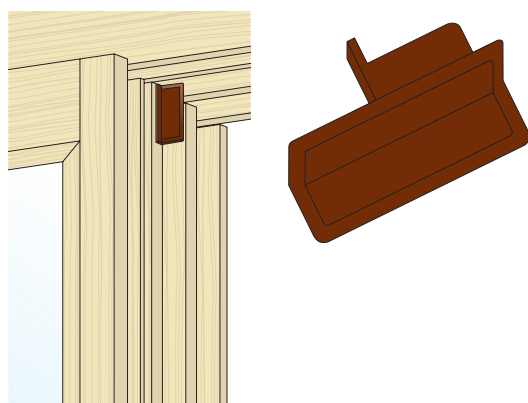

Q-Lon Seal	Part No.	Groove	Rebate
QL 3034	MIS-9093	3,0	–
QL 3053	MIS-9124	4,0	12,0
	MIS-9125	5,0	
	MIS-9184	4,0	18,0 – 20,0
	MIS-9185	5,0	
QL 3054	MIS-9103	3,0	10,0
QL 3070	MIS-9093	3,0	–
QL 3103	MIS-9124	4,0	12,0
	MIS-9125	5,0	
	MIS-9184	4,0	18,0 – 20,0
	MIS-9185	5,0	
QL 3141	MIS-9123	3,0	10,0
	MIS-9183	3,0	20,0

## Lozaron cover profiles for French windows

Colour coordinated profile made from TPE, compatible with acrylic paint.

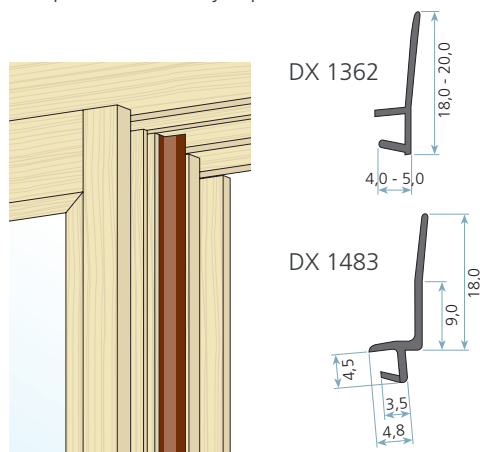

Q-Lon Seal	Part No.	Groove	Rebate
QL 3053	DX 1362	4,0 – 5,0	12 + 18 – 20
QL 3103			
QL 3141	DX 1483	3,0	10,0 – 20,0



### Q-Lon mitre cutters

Q-Lon mitre cutters have an insertion roll for 90° and end cut for assembly in the sash. Part no. MIS-9001-97.



### Q-Lon insertion roller

Profile manual roller.  
Part no. MIS-9007-01.



### Q-Lon dispenser

Seal dispenser  
for 1 coil.  
Part no.  
02800012.



### Installation of Q-Lon in the sash

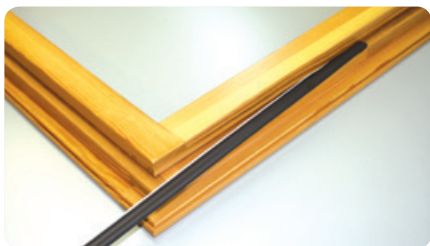

#### Step 1

The Q-Lon profile is pressed into the kerf at the centre of the sash.



#### Step 2

The Q-Lon pliers are placed in the rebate corner with the stop and a 90° mitre is cut out.



#### Step 3

The final cut: by positioning the pliers against the profile as shown, the final cut is made in the precise length.

# Q-Lon Polyurethane Foam Seals: colour range

The unique Q-Lon seal is made from a special polyurethane foam, contained in a weather resistant polyethylene liner.

The standard foam colour is natural. The liner is available in the following main colours (bronze for timber applications):

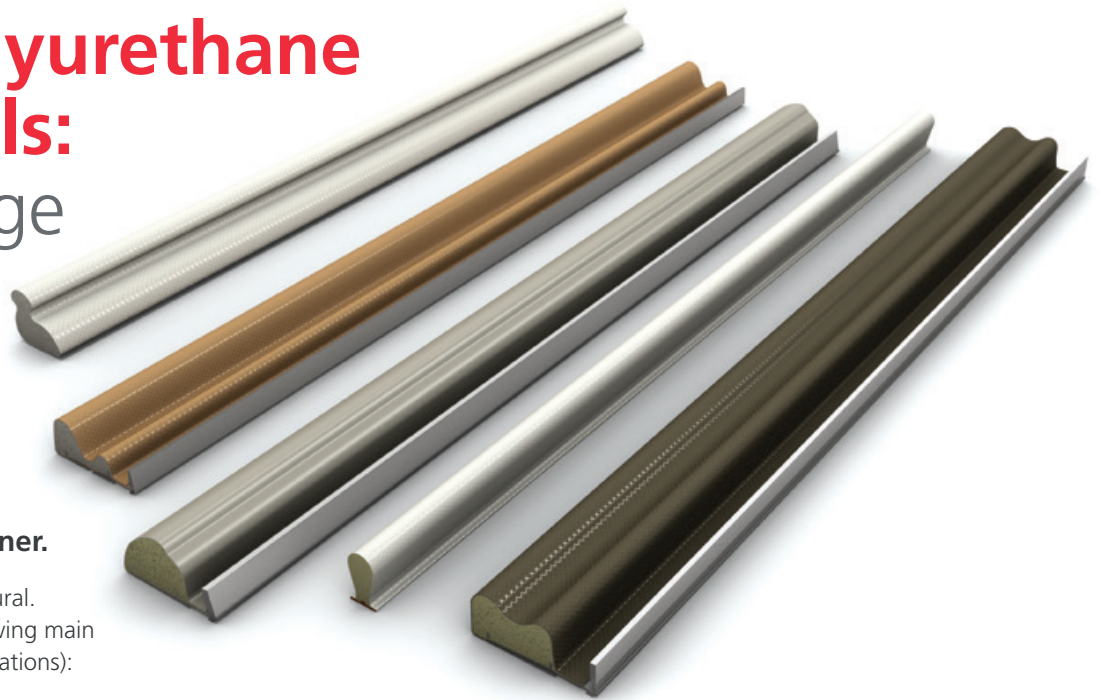

**White**



≈ RAL 9003

**Silver Grey**



≈ RAL 7001

**Bronze**

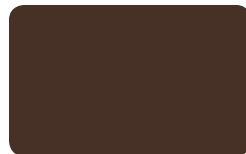

≈ RAL 8019

**Black**

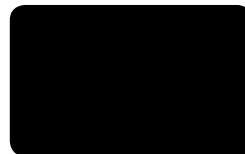

≈ RAL 9005

For further colour coordination, more options are available. Depending on the configuration, special conditions may apply. Upon request the foam can be produced in a different colour.

The liner can further be made available in the following colours:

**Beige**



≈ RAL 1001

**Light Oak**



≈ RAL 8003

**Ochre Brown**



≈ RAL 8001

**Fawn Brown**



≈ RAL 8007

**Chestnut Brown**



≈ RAL 8015

**Cream White**

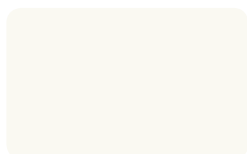

≈ RAL 9001

**Light Grey**

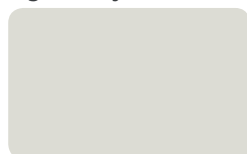

≈ RAL 7035

**Dark Grey**



≈ RAL 7002

**Graphite Grey**



≈ RAL 7024

**Note:** the combination of Q-Lon with an extrusion, formerly known as MAOF, is available in the 4 main colours plus light oak and ochre brown. See the separately available documentation.

## Case Study: Schreinerei Wundlechner, Germany

Wundlechner have specified Schlegel Q-Lon seals since 1991, utilising over 40,000 metres of QL 3053, QL 3054 and QL 3070 per year in the production of their windows.

Wundlechner build and maintain windows, doors and conservatories in various designs, optical styles, colours and shapes all utilising the superior performance of the Schlegel Q-Lon seal.

Franz Wundlechner:

*"Since 1991 we buy the Schlegel seals, because of their longevity and excellent noise reduction properties. For the long term they have good heat insulation in the rebate and overlap area, still after decades. With the Schlegel seal better insulation values are achieved than with regular seals. We apply them in new windows, entry doors and conservatories and use them for renovation of windows up to 40 years old. Our customers are very enthusiastic about the Schlegel seals."*

Leaking windows can be true energy wasters. A saving of up to 30% of the annual heating costs can be made if you seal leaky windows and avoid drafts. Wundlechner uses this to their advantage in their window refurbishment side of the business, ensuring old energy consuming windows are brought right up to date.



QL 3053

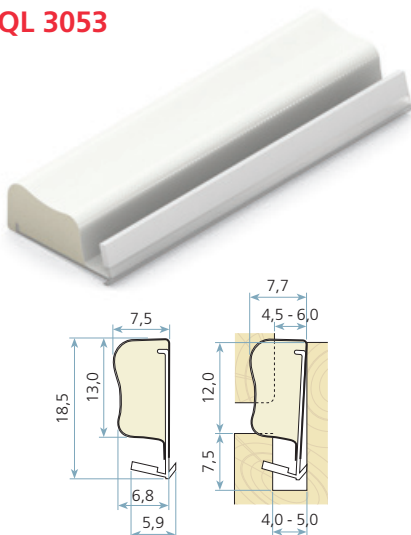

QL 3054

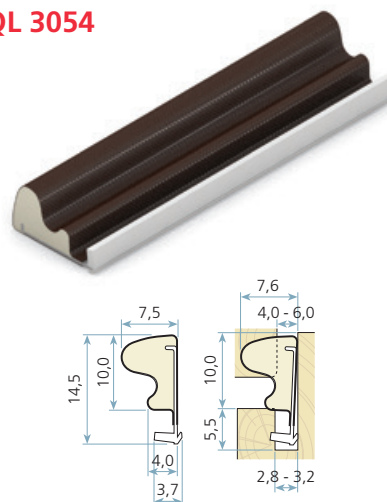

QL 3070

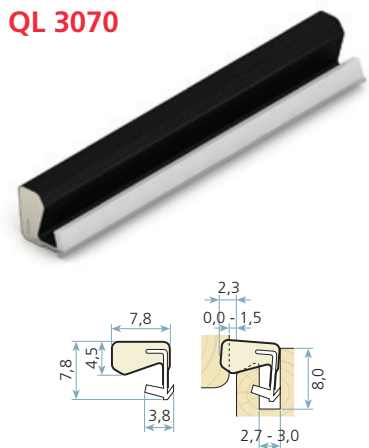



## SCHLEGEL INTERNATIONAL PRODUCT PORTFOLIO

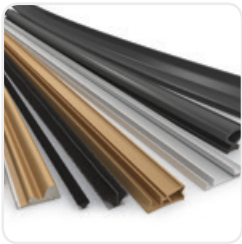

### Sealing solutions:

for windows, doors, window covering and interior design

- Foam weatherseals
- Brush pile weatherseals
- Extruded sealing profiles



### Hardware solutions:

for windows and doors

- Handles
- Hinges
- Locks

Care has been taken to ensure that the contents of this publication are accurate, but Schlegel and its subsidiary companies do not accept responsibility for errors or for information that is found to be misleading. Suggestions for, or description of, the end use or application of products or methods of working are for information only. All dimensions are in mm and are nominal. Schlegel reserve the right to change specification without prior notice. Schlegel's names and logos and all related trademarks (including 'SCHLEGEL', 'SCHLEGEL Red Square Logo', 'Red Square Logo' and 'Q-Lon'), trade names, and other intellectual property are the property of Schlegel Acquisition Holdings Limited trading as Schlegel International and cannot be used without its express prior written permission. All rights reserved.

© Schlegel Acquisition Holdings Limited trading as Schlegel International 2014.

[www.schlegel.com](http://www.schlegel.com)

Nov 14 | V2 | QloG